

HENSOMASTIK®

Mixed Penetration Seal EI 90 / EI 120

According to the European Technical Assessment ETA 15/0295
of 17/08/2016

Technical data sheet and assembly instructions for the
HENSOMASTIK® double-board Mixed Penetration Seal



Contents

1. **Technical description of the HENSOMASTIK® Mixed Penetration Seal EI 90 / EI 120**
2. **Technical data of the penetration seal system components**
 - 2.1 HENSOMASTIK® 5 KS Farbe, HENSOMASTIK® 5 KS viskos, HENSOMASTIK® 5 KS Spachtel
 - 2.2 Hardrock 040 mineral fibre board (complying with DIN EN 13162)
 - 2.3 Pipe collars AWM II (ETA 11/0208) and pipe collar Air Fire Tech Rorcol V30 (ETA 13/0758)
 - 2.4 Sectional insulation for non-flammable pipes with Rockwool RS 800
 - 2.5 Pipe insulation with HENSOTHERM® 7 KS Gewebe
3. **Overview of HENSOMASTIK® Mixed Penetration Seal EI 90 / EI 120**
4. **Applications of HENSOMASTIK® Mixed Penetration Seal EI 90 / EI 120**
5. **Assembly instructions HENSOMASTIK® Mixed Penetration Seal EI 90 / EI 120 for flexible and rigid wall constructions with wall thickness of minimum 100 mm**
 - 5.1 Application and fitting with **electric cables EI 90**
 - 5.2 Application and fitting with **flammable pipes EI 60 – EI 90**
 - 5.2.1 **Flammable pipes with pipe collar AWM II EI 90 “U/U”**
 - 5.2.2 **Plastic and composite pipes with HENSOTHERM® 7 KS Gewebe pipe wraps “U/U”**
 - 5.2.3 Assembly instructions for **HENSOTHERM® 7 KS Gewebe pipe wraps**
 - 5.3 **Non-flammable pipes of steel & copper with sectional insulation EI 90 / EI 120**
 - 5.3.1 **Non-flammable pipes of steel & copper with sectional insulation Rockwool RS 800 (LS/LI) EI 90 / EI 120 “U/C”**
 - 5.3.2 **Metal pipes with Rockwool RS 800 insulation, local sustained (LS) or continued sustained (CS)**
 - 5.3.3 **Non-flammable pipes of steel & copper with insulation Armaflex Protect (LS) EI 90 “C/U”**
 - 5.3.4 **Non-flammable pipes of steel & copper with insulation Armaflex AF (LS) and HENSOTHERM® 7 KS Gewebe EI 90 “C/U”**
6. **Assembly instructions for HENSOMASTIK® Mixed Penetration Seal EI 90 / EI 120 in rigid floor constructions with floor thickness of minimum 150 mm**
 - 6.1 Application and fitting with **electric cables and trays EI 90**
 - 6.2 Plastic pipes and conduits with **AWM II EI 90 / EI 120 “U/U”**
 - 6.3 Plastic and composite pipes with **HENSOTHERM® 7 KS Gewebe pipe wraps “U/U”**
 - 6.4 Application and fitting with **non-flammable pipes EI 90 / EI 120**
 - 6.4.1 **Non-flammable pipes of steel & copper with sectional insulation Rockwool RS 800 (LI), length 2 × 1,000 mm, EI 120 “U/C”**
 - 6.4.2 **Non-flammable pipes of steel & copper with insulation Armaflex AF (LS), length 2,000 mm and HENSOTHERM® 7 KS Gewebe EI 90 / EI 120 “C/U”**
 - 6.4.3 **Non-flammable pipes of steel & copper with insulation Armaflex Protect (LS), length 2,000 mm, EI 120 “C/U”**

LS = local insulation continuous in the sealing area | LI = local insulation intermittent in the sealing area

Pipe end configuration	Test condition		
	U/U	C/U	U/C
In the furnace	Open	Closed	Open
On the outside	Open	Open	Closed

NOTE: These assembly instructions are for your consultation. They do not serve in lieu of the details in the underlying European Technical Assessment **ETA 15/0295**. The complete ETA 15/0295 must be printed out and made available at the installation site.

1. Technical description of the HENSOMASTIK® Mixed Penetration Seal EI 90 / EI 120

HENSOMASTIK® Mixed Penetration Seal EI 90 / EI 120 is a system consisting of 2 × 50 mm thick Hardrock 040 mineral fibre board coated on the outsides with **HENSOMASTIK® 5 KS Farbe/viskos** and designed as a seal for metal pipes, plastic pipes, and electric cables serving to restore the fire safety of lightweight and solid wall structures and solid floor structures carrying the various metal supply lines with insulation, plastic pipes, composite pipes, and electric cables.

HENSOMASTIK® Mixed Penetration Seal EI 90 / EI 120 does not contain any carcinogenic or mutagenic substances or flame retardants.

HENSOMASTIK® Mixed Penetration Seal EI 90 / EI 120 does not contain any dangerous substances as defined in Directive 67/548/EEC and (EC) Directive No. 1272/2008 or on the EGDS Indicative List of Regulated Dangerous Substances with respect to the assembly conditions for the construction product and the resulting release scenarios.

The applicable usage category of **HENSOMASTIK® Mixed Penetration Seal EI 90 / EI 120** with respect to BWR 3 (hygiene, health, and environment) is IA/1, S/W3.

2. Technical data of the penetration seal system components

2.1 HENSOMASTIK® 5 KS Farbe, HENSOMASTIK® 5 KS viskos, HENSOMASTIK® 5 KS Spachtel

HENSOMASTIK® 5 KS is an abrasive, medium-viscosity, and non-hygroscopic, water-based fire protection coating in the versions “**Farbe**”, “**viskos**”, and “**Spachtel**”.

This is a dispersion coating we manufacture ourselves with organic binders, water, mineral fillers, pigments, and additives.

The fire protection coating **HENSOMASTIK® 5 KS** is part of the **Green Product** line at Rudolf Hensel GmbH, classified as “low emission”, and it does not contain any solvents, borates, plasticisers, halogens, formaldehydes, or alkylphenol ethoxylates (APEs).

HENSOMASTIK® 5 KS

- EN 13501-1 classification as an indoor and outdoor construction material
- Free of solvents and silicone
- Weather-proof / UV resistant under DIN 53384
- Age resistant
- Mechanical stability
- Retrofits and subsequent adjustments possible
- Temperature resistant after completion up to 20 °C

Packaging sizes: **HENSOMASTIK® 5 KS** in the versions “**Farbe**” and “**viskos**” is delivered in 6 kg / 12.5 kg plastic buckets and in the version “**Spachtel**” in 310 ml cartridges and 6 kg / 12.5 kg plastic buckets.

Work safety: Processing **HENSOMASTIK® 5 KS** must comply with the regulations for work safety and environmental protection **GISCODE:** M-DF01

Before using **HENSOMASTIK® 5 KS**, please consult its safety data sheet available as a PDF download from www.rudolf-hensel.de

Storage: The storage and transport temperatures must lie within +5 °C and +30 °C (free of frost!).

HENSOMASTIK® 5 KS Farbe/viskos can be stored for up to twelve months in the original packaging.

HENSOMASTIK® 5 KS SP can be stored for up to twelve months in the original packaging.

Carefully seal opened packaging after use!

Technical data and properties

HENSOMASTIK® 5 KS Farbe, HENSOMASTIK® 5 KS viskos, HENSOMASTIK® 5 KS Spachtel

Product versions	HENSOMASTIK® 5 KS Farbe	HENSOMASTIK® 5 KS viskos	HENSOMASTIK® 5 KS Spachtel
Colour	White	White	White
Consistency	Liquid	Viscous	Viscous
Apparent density	1.35 +/- 0.2g/cm ³	1.35 +/- 0.2g/cm ³	1.46 +/- 0.2g/cm ³
Usage category with respect to weathering effects	Typ X: Also designed for use outdoors	Typ X: Also designed for use outdoors	Typ X: Also designed for use outdoors
Fire properties as defined in DIN EN 13501-1	Class E	Class E	Class E
VOC content	< 1g/l	< 1g/l	< 1g/l
Classified and approved according to	ETAG 026-2	ETAG 026-2	ETAG 026-2

2.2 Mineral fibre boards

The tested and approved Hardrock 040 mineral fibre boards (complying with DIN EN 13162) in **HENSOMASTIK® Mixed Penetration Seal EI 90 / EI 120** exhibit an apparent density of about 150 kg/m³ and a melting point ≥ 1000 °C and comply with EN 13501-1 construction material class A1 (non-flammable). Board thickness of the **HENSOMASTIK® double-board mixed penetration seal: 2x 50 mm**

2.3 Pipe collars

AWM II approved by the DIBt of Berlin, from Z-200.2-58, as an emissions-rated construction product, European Technical Assessment ETA-11/0208 **Air Fire Tech Rorcol V30** classified in accordance with EN 13501- 2, European Technical Assessment ETA-13/0758

2.4 Sectional insulation for non-flammable pipes

Rockwool RS 800 with a melting point ≥ 1000 °C, non-flammable A2L-s1, d0 according to EN 13501-1

2.5 Sectional insulations wrapped in **HENSOTHERM® 7 KS Gewebe**

HENSOTHERM® 7 KS Gewebe: Construction material approval ETA 13/0092, indoor and outdoor applications, usage categories: Y2/Z1/Z2, highly flexible, fabric secured with clips, straps, or galvanised wire

 2.5.1 **Armaflex AF:** Euroclass B/BL-s3,d0 according to EN 13501-1

Kaiflex ST: Euroclass BL-s3,d0 according to EN 13501-1

 2.5.2 **Armaflex Ultima, Armaflex LS, Kaiflex KK plus and Klimarock**

Armaflex Ultima: Euroclass BL-s1, d0

Armaflex LS: BL-s2, d0

Kaiflex KK plus: BL-s2, d0

Klimarock: non-flammable, A1

3. Overview of HENSOMASTIK® Mixed Penetration Seal EI 90 / EI 120



HENSOMASTIK® mixed penetration seal systems are used to seal metal pipes, flammable pipes, and electric cables, thereby restoring the fire safety of wall and floor structures provided with openings for supply lines.

HENSOMASTIK® mixed penetration seals in lightweight and solid walls

1	HENSOMASTIK® 5 KS Farbe or HENSOMASTIK® 5 KS viskos
2	Hardrock 040 mineral fibre boards
3	AWM II or Air Fire Tech Rorcol V30
4	HENSOTHERM® 7 KS Gewebe for section insulation
5	HENSOMASTIK® 5 KS Spachtel
6	Sectional insulation (see pages 4, 2.5) 1 m
7	Non-flammable pipes
8	Flammable pipes
9	Cable tray
10	Electric cables
11	Solid wall
12	Lightweight wall
13	Rockwool RS 800
14	Labelling plate

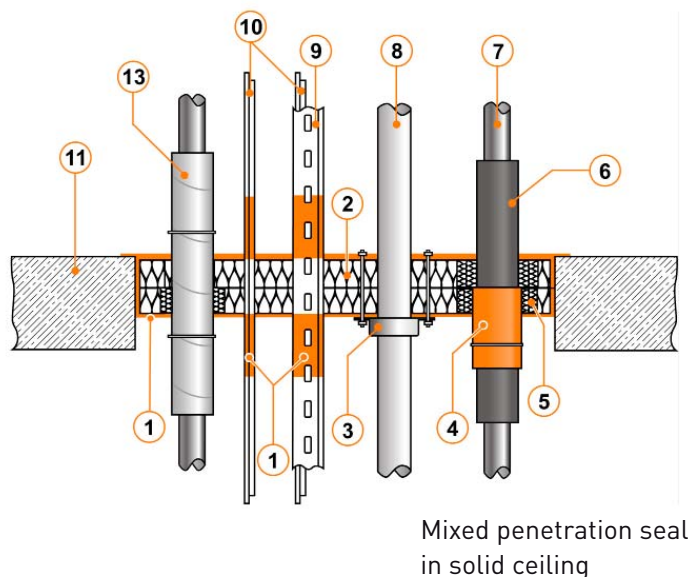
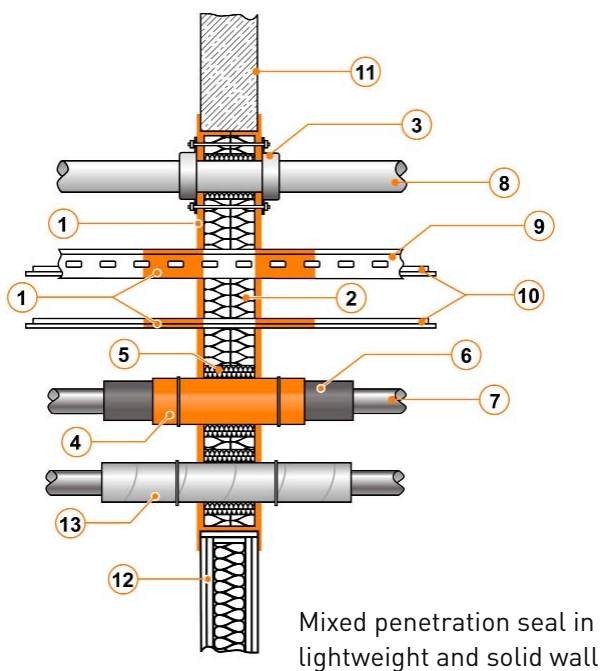
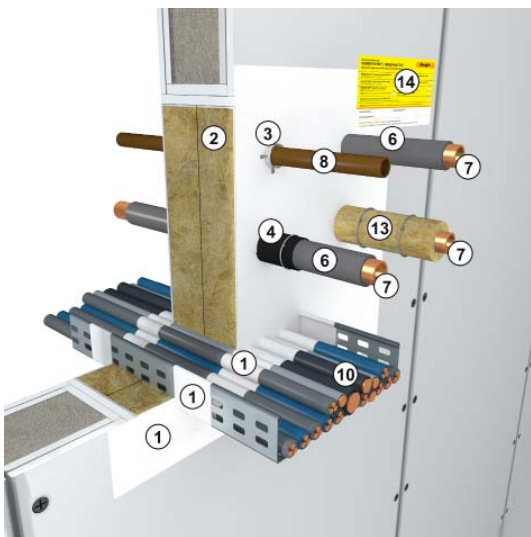

4. Applications of HENSOMASTIK® Mixed Penetration Seal EI 90 / EI 120

Lightweight walls

The wall must be at least 100 mm thick and consist of a wood or steel strut frame* lined on both sides with at least two layers of 12.5 mm thick boards.

* There must be a minimum distance of 100 mm between the seal and the supports, and this gap must be filled with at least 100 mm of Class A1 or A2 insulating material (as defined in EN 13501-1). The supporting structure must have been classified for the required fire resistance period as defined in EN 13501-2.

Solid structural walls

The wall must be at least 100 mm thick and be of concrete, aerated concrete, or masonry with a minimum density of 650 kg/m³.

HENSOMASTIK® mixed penetration seal in lightweight and solid walls

Installation situation	Thickness of Hardrock 040 mineral fibre boards for EI 90 / EI 120	Max sealant size in m ²
Lightweight wall ≥ 100 mm	2 x 50 mm	2.4 m ² (2,000 mm x 1,200 mm)
Solid wall ≥ 100 mm	2 x 50 mm	2.4 m ² (2,000 mm x 1,200 mm)

Solid ceilings

The ceiling must be at least 150 mm thick and be of concrete, aerated concrete, or masonry with a minimum density of 650 kg/m³.

HENSOMASTIK® Kombi-Weichschott in Massivdecken

Installation situation	Thickness of Hardrock 040 mineral fibre boards for EI 90 / EI 120	Max sealant size in m ²
Solid ceiling ≥ 150 mm	2 x 50 mm	2.4 m ² (2,000 mm x 1,200 mm)

HENSOMASTIK® Mixed Penetration Seal systems EI 90 / EI 120 can be used as sealant in conjunction with insulated metal pipes, combustible pipes, and electric cables, single or bundled.

The maximum **sealing size in lightweight and solid wall structures** is 2,000 mm x 1,200 mm (H x W) and in solid ceiling structures 2,000 mm x 1,000 mm.

Also an empty seal can be installed. Supply lines must be protected at a max distance of 250 mm from both sides of the wall structure and from the top of the floor structure.

5. Assembly instructions for HENSOMASTIK® Mixed Penetration Seal EI 90 / EI 120 in lightweight and solid wall

HENSOMASTIK® mixed penetration seals may be applied by trained and qualified personnel only.

The mixed penetration seal system may not be processed at material, substrate, or air temperatures below +5 °C or at air humidities exceeding 80%. Before installation, the reveals and the rough opening of the structural element must be cleaned and all loose parts removed!

Up to 60% of **HENSOMASTIK® mixed penetration seals** can be covered with supply lines. Retrofits on **HENSOMASTIK® mixed penetration seals** are possible when 60% of the area has not yet been covered.

Step 1: Transfer the measurements of the rough opening of the structural element (length × width) to the boards, and cut these to size. These must be used to cut out the individual pieces that must be custom-fitted in all openings between the lines and between these and the reveal.

TIP: A contour gauge (template) can be used to transfer electric cables, pipes, and cable runs to the fire protection panel.

Step 2: The outsides of the cut mineral wool panels are coated with a fire protection coating at least 1 mm thick in the dried state.

TIP: This can be obtained in only the one operation with **HENSOMASTIK® 5 KS viskos** as the most cost-effective solution after the cut pieces have been fitted.

Alternatively, prefabricated or ready-coated mineral fibre boards can be used as the cut pieces.

Step 3: Before installation, the reveal and the cut edges of the mineral fibre boards must be coated with **HENSOMASTIK® 5 KS Farbe**, **HENSOMASTIK® 5 KS viskos**, or **HENSOMASTIK® 5 KS SP**. Not until afterwards may the cut pieces be installed in the carcass opening.

Step 4: Gaps, joints, and wedges are filled completely with **HENSOMASTIK® 5 KS SP**. Gaps, joints, or wedges wider than 10 mm are first stuffed with loose mineral fibre material towards the centre of the mixed penetration seal and then filled with **HENSOMASTIK® 5 KS SP**. Bear in mind that the circumferential gap around pipes may not be wider than 10 mm!

Step 5: Tape off the circumference of the opening **2 cm** above the rough opening of the structural element. This will allow you to coat the circumferences of the transitions/join between the mineral fibre boards and the wall or the ceiling at least **2 cm** beyond the mineral fibre board with at least 1 mm (dry film thickness) of **HENSOMASTIK® 5 KS Farbe** or **HENSOMASTIK® 5 KS viskos**.

For **wall and ceiling installations**, cables and cable runs must be coated **30 cm** as measured from the wall/sealant with at least **1 mm** (dry film thickness) of **HENSOMASTIK® 5 KS Farbe** or **HENSOMASTIK® 5 KS viskos**.

IMPORTANT! Ceiling sealant must be protected additionally against access!

Finally, the ready **HENSOMASTIK® mixed penetration seal** is fitted visibly and permanently with a **labelling plate** containing all the details and provided for this purpose. This labelling plate is available from Rudolf Hensel GmbH.

Top coating of the penetration sealing – If required it is possible to overcoat with HENSOTOP 84 or HENSOTOP 84 AQ (50–100 µm dry film thickness) in RAL or NCS colour shades. Individual colour shades on request.

NOTE: These assembly instructions are for your consultation. They do not serve in lieu of the details in the underlying European Technical Assessment **ETA 15/0295**. The complete ETA 15/0295 must be printed out and made available at the installation site.

5. Assembly instructions HENSOMASTIK® Mixed Penetration Seal EI 90 / EI 120 for flexible and rigid wall constructions with wall thickness of minimum 100 mm

Services	Types
Cables	<ul style="list-style-type: none"> • Sheathed electrical cables up to 80 mm diameter • Telecom cables up to 21 mm diameter
Cable bundles	<ul style="list-style-type: none"> • Bundles of the above up to 100 mm in diameter
Cable Supports	<ul style="list-style-type: none"> • Perforated and unperforated steel cable trays and ladders
Plastic pipes with AWM II pipe collars	<ul style="list-style-type: none"> • PE pipes in accordance with EN 1519-1, EN 12666-1, EN12201-2 • Friaphon (by FRIATEC) pipes • PVC-U pipes in accordance with EN 1329-1, EN 1453-1 and EN 1452-1 • PP pipes in accordance with EN 1852-1: 2009
Plastic pipes with HENSOTHERM® 7KS Gewebe pipe wrap	<ul style="list-style-type: none"> • PE pipes in accordance with EN 1519-1, EN 12666-1, EN12201-2 • PVC-U pipes in accordance with EN 1329-1, EN 1453-1 and EN 1452-1 • PP pipes in accordance with EN 1852-1: 2009
Metal pipes with Rockwool RS800 (LI) insulation	<ul style="list-style-type: none"> • Copper • Mild & stainless steel • Cast Iron
Metal pipes with Armaflex Protect (LS) insulation	<ul style="list-style-type: none"> • Copper • Mild & stainless steel • Cast Iron
Metal pipes with Armaflex AF (LS) insulation	<ul style="list-style-type: none"> • Copper • Mild & stainless steel • Cast Iron

Permitted Distances

Maximum seal size: 2000 mm high x 1200 mm wide

- a1: between cable/cable trays and metal pipes ≥ 50 mm
- a2: between cable/cable trays and plastic pipes ≥ 50 mm
- a3: between metal pipes and plastic pipes ≥ 25 mm
- a4: between plastic pipes ≥ 40 mm
- a5: between metal pipes ≥ 40 mm
- a6: between cable trays ≥ 30 mm
- b1: between cable/cable trays and the upper seal edge: ≥ 25 mm
- b2: between cable/cable trays and the side seal edge: ≥ 25 mm
- b3: between cable/cable trays and the lower seal edge: ≥ 50 mm
- b4: between metal pipes and the side seal edge: ≥ 30 mm
- b5: between plastic pipes and the side seal edge: ≥ 30 mm

Distance 1st support service ≤ 250 mm

5.1 Application and fitting with electric cables EI 90

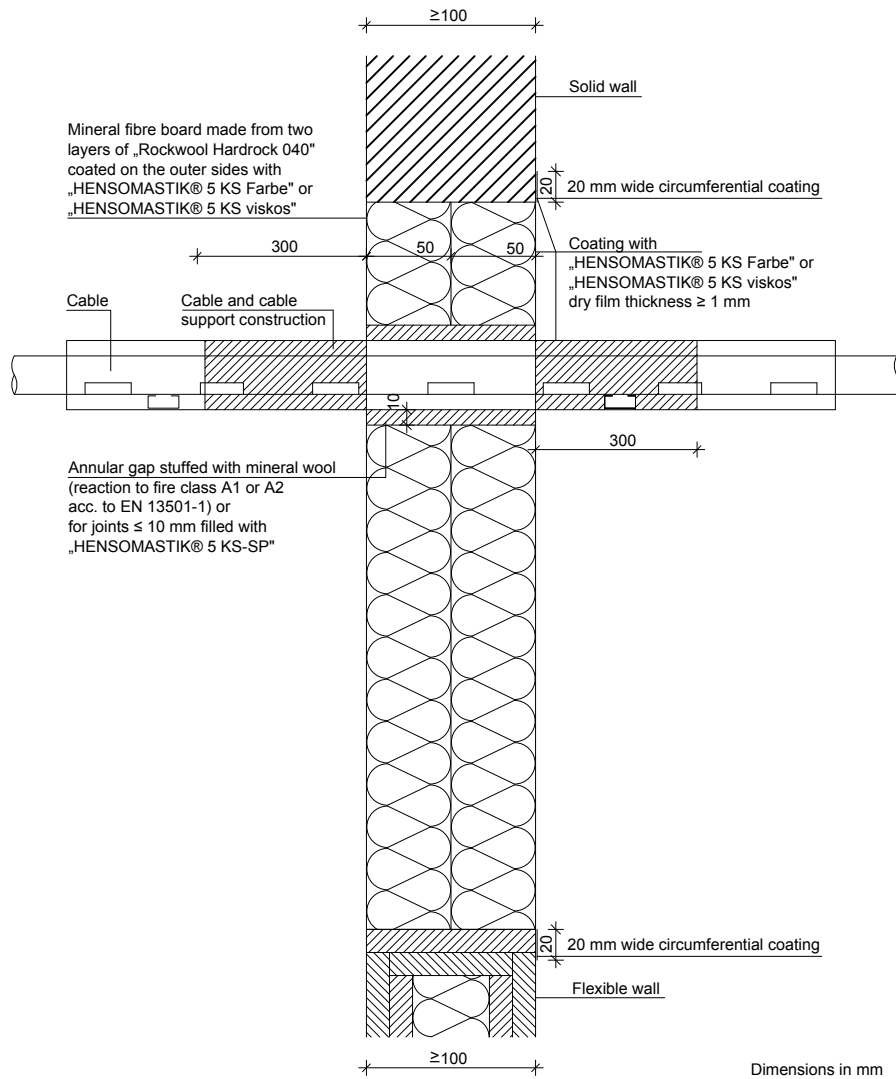

Services	Insulation/Coating	Classification
Sheathed electrical cables up to 80 mm diameter	1 mm DFT HENSOMATIK 5KS Farbe coating extending 300 mm from both faces of the seal	EI 90
Telecoms cables up to 21 mm diameter		
Bundles of above cables up to 100 mm diameter		
Cable supports		

5.2 Application and fitting with flammable pipes EI 60 – EI 90

5.2.1 Flammable pipes with pipe collar AWM II EI 90 “U/U”

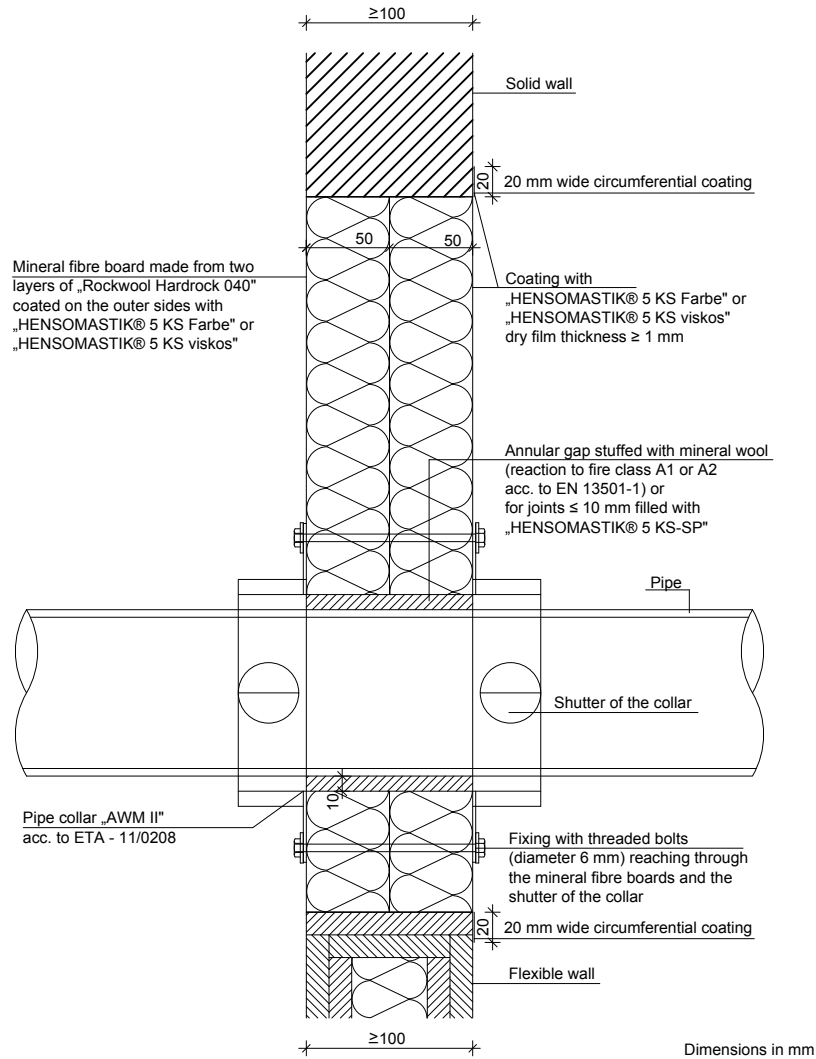

Services	Pipe diameter mm	Pipe wall thickness mm	Collar inlay size mm	Classification
PP pipe	32-50	1.8-4.6	25.4 x 6.4	EI 90 U/U
	110	2.7	25.4 x 17.1	
	110	11.2	25.4 x 19.2	EI 60 U/U
Illustrated classified pipe dimensions				
<p>Graph showing Pipe wall thickness (mm) vs Diameter (mm) for PP EI 90-U/U. The graph plots three data points: (50, 4.6), (50, 2.7), and (110, 2.7).</p>				

5.2.1 Flammable pipes with pipe collar AWM II EI 90 “U/U”

Services	Pipe diameter mm	Pipe wall thickness mm	Collar inlay size mm	Classification	
Friaphon pipe	52	2.8	75 x 6	EI 90 U/U	
	78	4.9			
	110	5.3			
	135	5.6	75 x 12		
Kelox Kelit	63	4.5	25.4 x 12.8	EI 90 U/U	
Geberit Mepla	63	4.5	25.4 x 12.8		
PVC-U pipe	32	1.8-5.6	25.4 x 6.4	EI 90 U/U	
	40				
	50				
	63	1.8-12.3	25.4 x 12.8		
	75				
	90				25.4 x 17.1
	110				25.4 x 19.2
	125	2.5-9.2	38.1 x 25.6		EI 60 U/U
	160	3.2			
	160	11.9			

Illustrated classified pipe dimensions

Diameter (mm)	Wall Thickness (mm)
50	1.8
50	12.3
110	1.8
110	12.3
110	9.2
125	2.5
125	9.2
160	3.2

Services	Pipe diameter mm	Pipe wall thickness mm	Collar inlay size mm	Classification	
PE pipe	32	1.8-4.6	25.4 x 6.4	EI 90 U/U	
	40				
	50				
	63	2.7-3.1	25.4 x 12.8		
	75				
	90				25.4 x 17.1
	110				25.4 x 19.2
	125	3.1-11.4	38.1x25.6		
	140	4.0-14.6			
	160				

Illustrated classified pipe dimensions

Diameter (mm)	Wall Thickness (mm)
50	1.8
50	11.4
110	2.7
125	3.1
125	11.4
160	4.0

5.2.2 Plastic and composite pipes with HENSOTHERM® 7 KS Gewebe pipe wraps

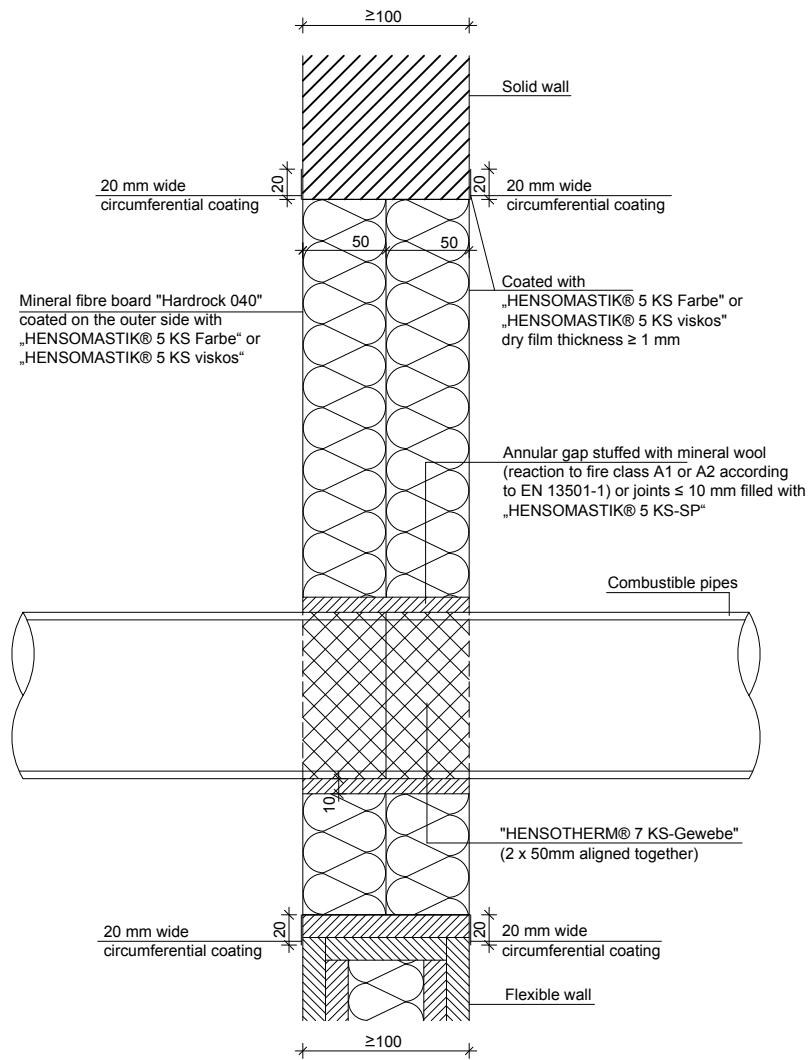

Dimensions in mm

Pipes	Maximum Pipe diameter mm	Pipe wall thickness mm	Layers of HENSOTHERM 7KS Gewebe pipe wrap	Classification
PVC-U	50	2.4-3.6	2	EI 90 U/U
	75	3.6-5.6	3	
	90	4.3-6.7	4	
Illustrated classified pipe dimensions				

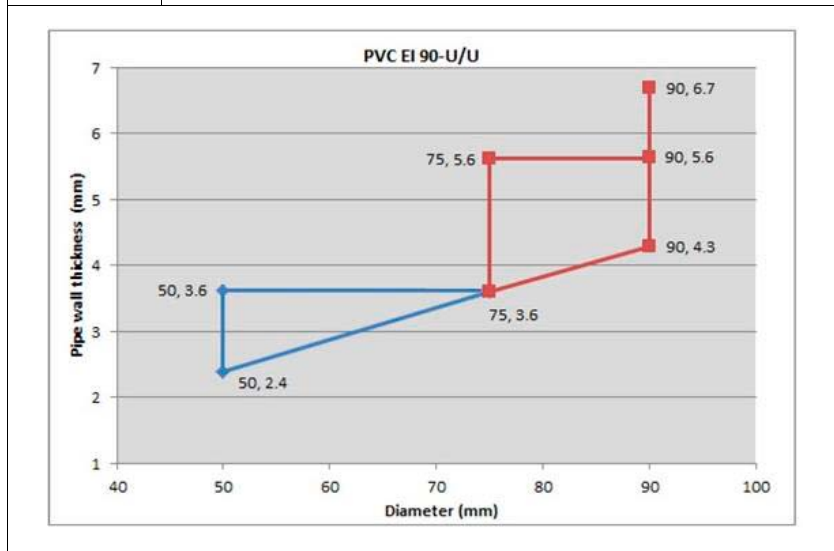

5.2.2 Plastic and composite pipes with HENSOTHERM® 7 KS Gewebe pipe wraps

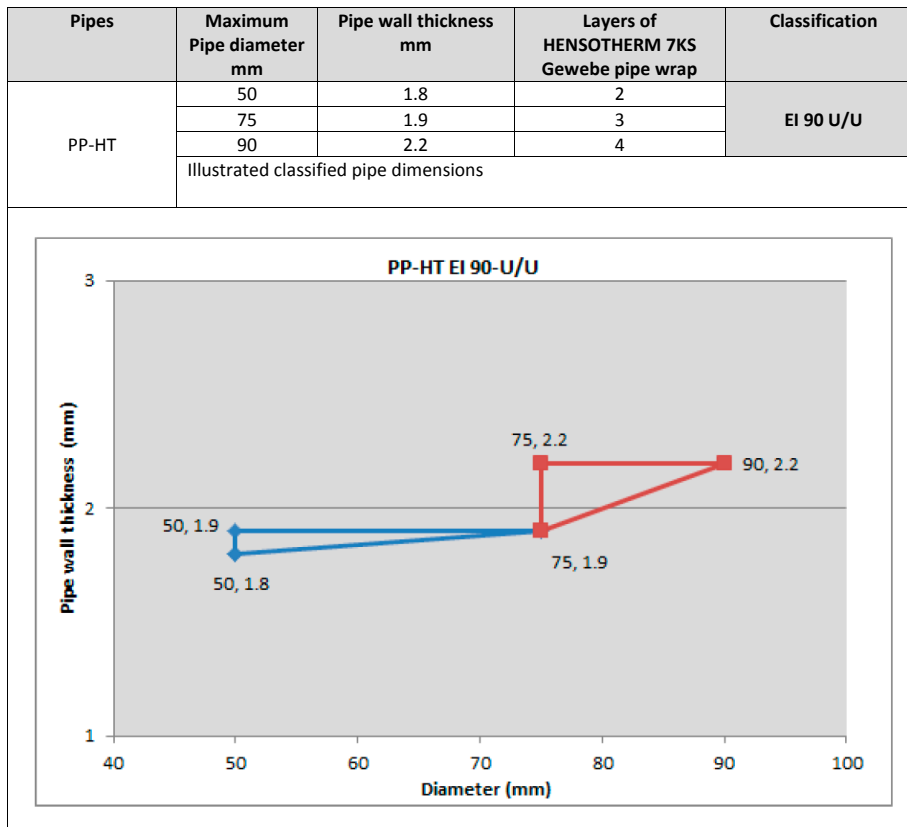
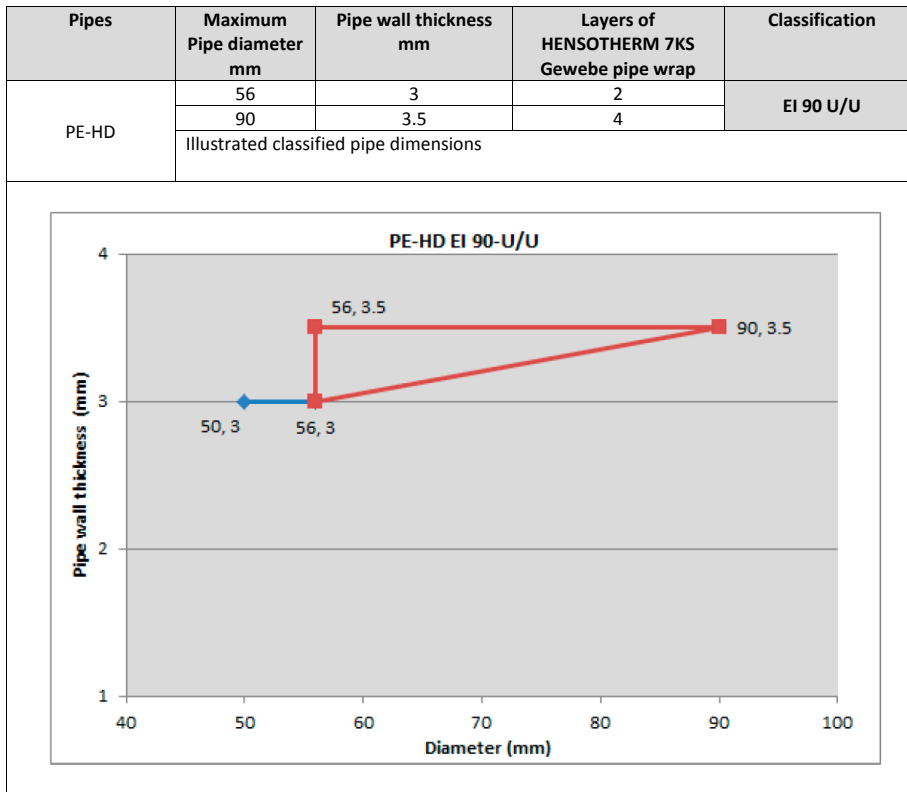

5.2.2 Plastic and composite pipes with HENSOTHERM® 7 KS Gewebe pipe wraps

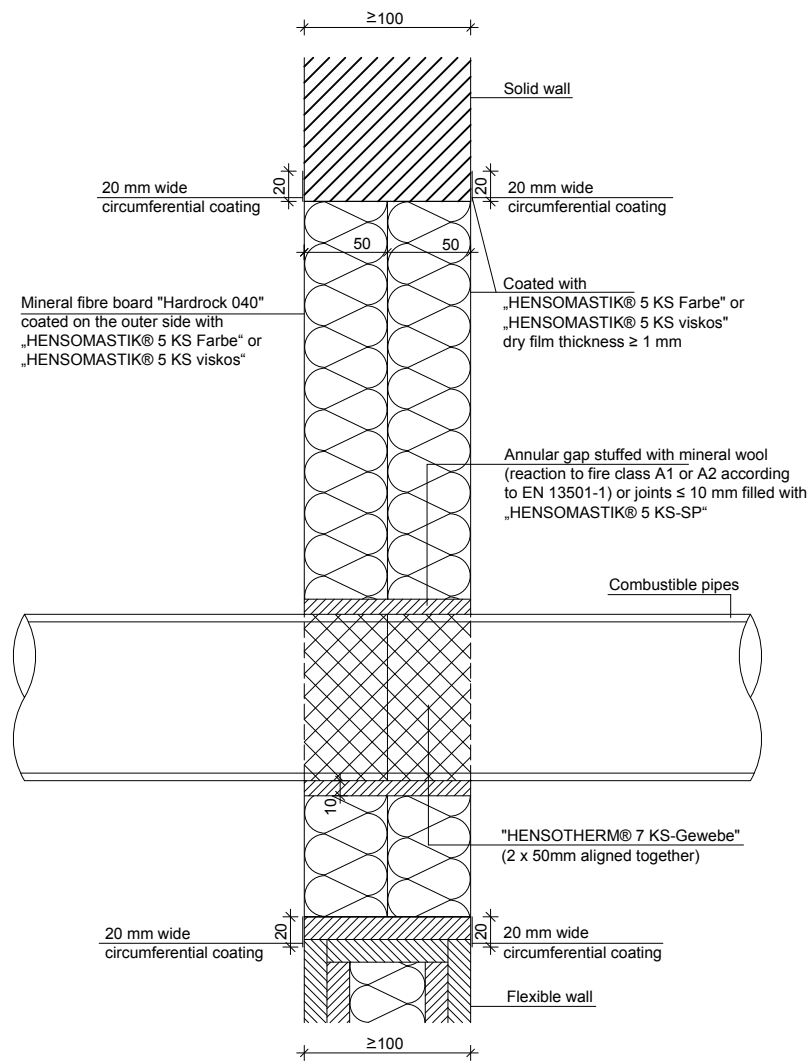

Dimensions in mm

Pipes	Maximum Pipe diameter mm	Pipe wall thickness mm	Layers of HENSOTHERM 7KS Gewebe pipe wrap	Classification	
Geberit Silent dB20	56	3.2	2	EI 90 U/U	
	90	5.5	4		
Geberit Silent PP	50	2	2		
	90	3.1	4		
Polokal NG	50	2	2		
	90	3	4		
Polokal 3S	75	3.8	3		
	90	4.5	4		
Flex-Schlauch FX	25*	2	2		EI 90 C/C
	32^	2	2		
Geberit Melpa	32	3	3	EI 90 U/C	
	63	4.5	4		
Viega Raxofix	32	3.2	3		
	63	4.5	4	EI 30 U/C	

* With or without 1x NYM-J, 5RE cable

^ With or without 1x NYM-J 5x6, 0 RE cable

5.2.3 Assembly instructions for HENSOTHERM® 7 KS Gewebe pipe wraps



The thick side of the material is wrapped to the outside!

HENSOTHERM® 7 KS Gewebe pipe wraps for plastic and composite pipes in HENSOMASTIK® Mixed Penetration Seals **up to EI 120**

- Intumescent pipe wrap for sealing plastic and composite pipes **up to 90 mm** diameter in flexible walls, solid walls and floors
- Flexible; easy and fast installation
- Low space requirement due to low installation height
- Measurements of the pipe wrap 50 mm width and 2 mm thick
- The following combustible pipes are certified: PVC-U, PE-HD, PP-HT, Geberit Silent dB20, Geberit Silent PP, Polokal NG, Polokal 3S, Geberit Mepla, Flex-Schlauch, Flex-Schlauch FX

Assembly instructions*:



Reveals and rough opening must be cleaned



Cut HENSOTHERM® 7 KS Gewebe pipe wrap, acc. to the requirements, to size



Wrapping* of both sides of the combustible pipe flush with the surface of the penetration seal



Fixing of the finished wrappings with duct tape



Professional installation of the HENSOMASTIK® 5 KS Mixed Penetration Seal



Sealing of the ring gap with HENSOMASTIK® 5 KS SP

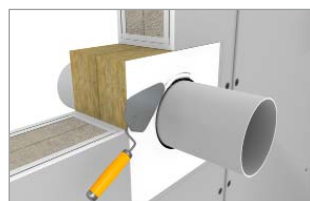

Smoothing of the surface with a spatula



Marking of the HENSOMASTIK® 5 KS Mixed Penetration Seal

***IMPORTANT!** The thick coated side of the HENSOTHERM® 7 KS Gewebe has to be **wrapped on the outer wall of the pipes!**

Outer pipe diameter	Installation	Number of windings	Length in wall	Length in wall
32mm	wall / floor	2	2x 250 mm	250 mm
40mm	wall / floor	2	2x 300 mm	300 mm
50mm	wall / floor	2	2x 360 mm	360 mm
63mm	wall / floor	3	2x 680 mm	680 mm
75mm	wall / floor	3	2x 790 mm	790 mm
90mm	wall / floor	4	2x 1,250 mm	1,250 mm

5.3 Non-flammable pipes of steel & copper with sectional insulation EI 90 / EI 120 "U/C"

5.3.1 Non-flammable pipes of steel & copper with sectional insulation Rockwool RS 800 (LS) EI 90 "U/C"

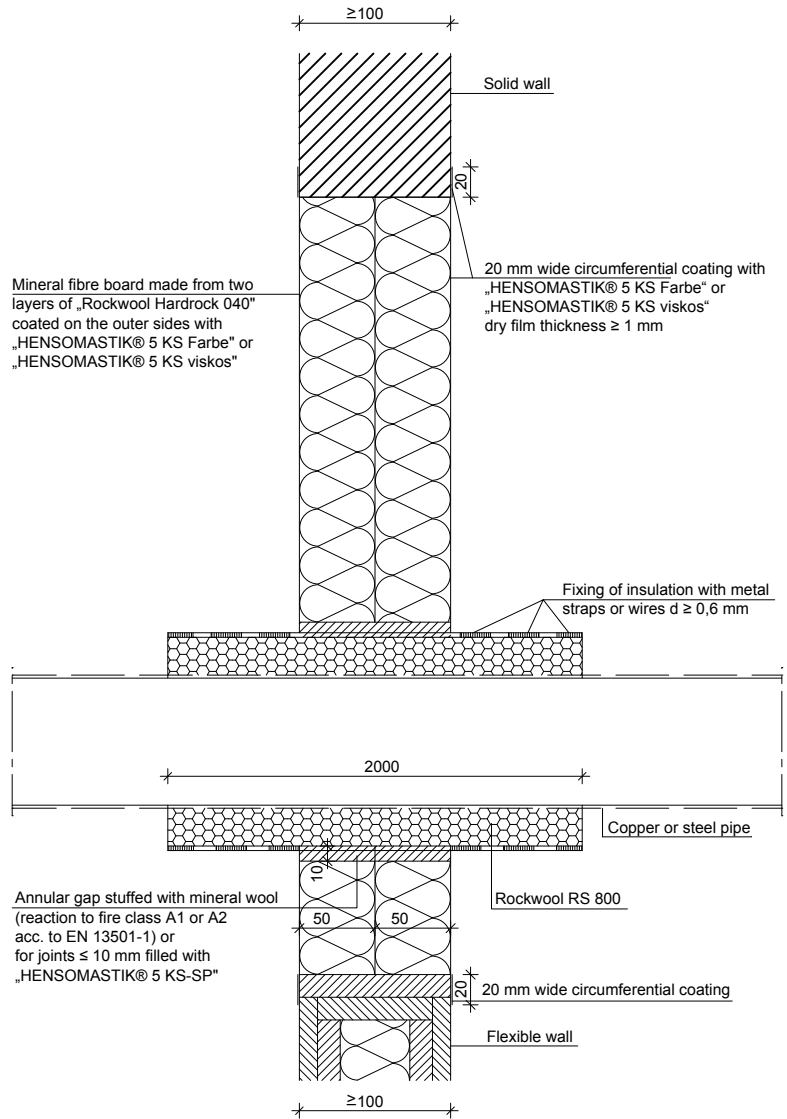

The length of the local insulation may be increased but not reduced.

Dimensions in mm

Services	Pipe diameter mm	Pipe wall thickness mm	Insulation thickness mm	Classification
Kelox Kelit with 'LS' Rockwool RS800 insulation 2000 mm long	63	4.5	30 mm	EI 90 U/C
Geberit Mepla with 'LS' Rockwool RS800 insulation 2000 mm long				

5.3.1 Non-flammable pipes of steel & copper with sectional insulation Rockwool RS 800 (LI) EI 90 / EI 120 "U/C"

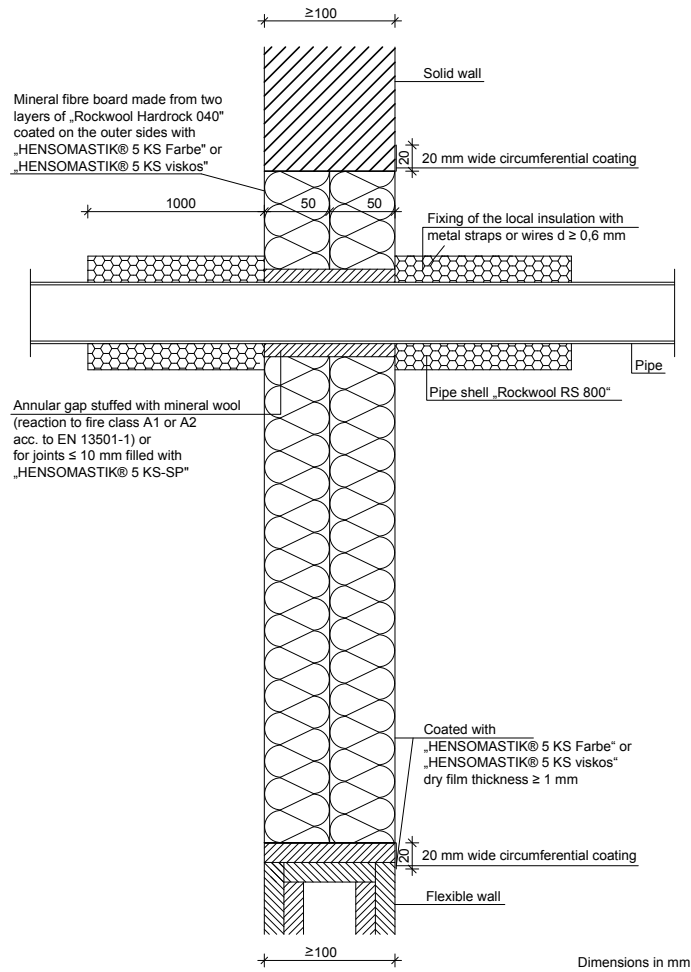

The length of the local insulation may be increased but not reduced.

Services	Pipe diameter mm	Pipe wall thickness mm	Insulation thickness mm	Classification
Steel or cast iron pipe	Up to 22	1.0-11	20 (min.)	EI 90 U/C
	Up to 48.3	2.6-14.2		
	Up to 139.7	4.0-14.2	30 (min.)	
Illustrated classified pipe dimensions				
Copper pipe	Up to 15	1.0-7	19 (min.)	EI 120 U/C
	Up to 22	1.0-11	20 (min.)	
	Up to 42	1.5-14.2	25 (min.)	
	Up to 76.1	2.0-14.2	30 (min.)	EI 90 U/C
	Up to 88.9	2.0-14.2	30 (min.)	
Illustrated classified pipe dimensions				

5.3.2 Metal pipes with Rockwool RS 800 insulation, local sustained (LS) or continued sustained (CS)

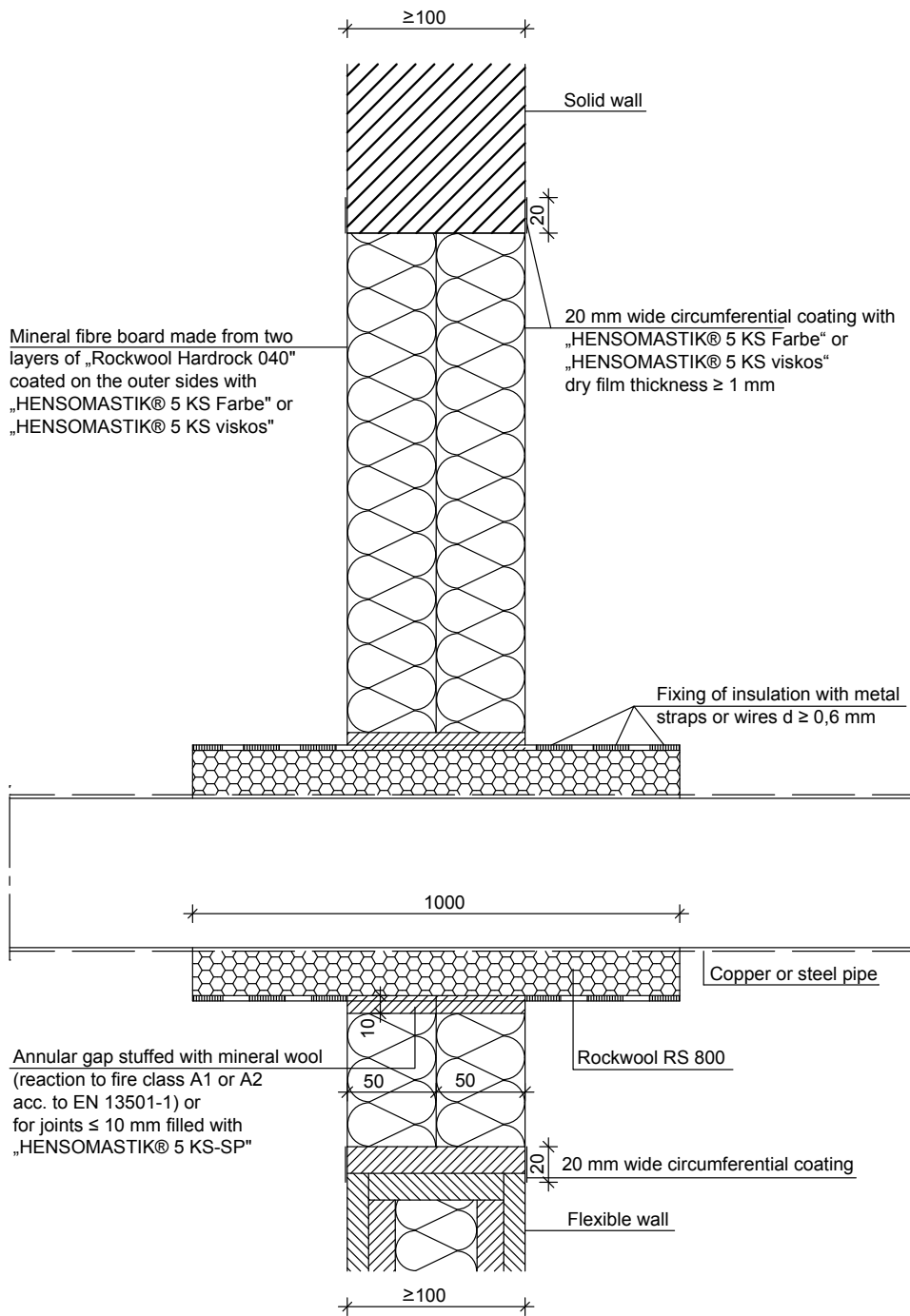

The length of the local insulation may be increased but not reduced.

Dimensions in mm

Pipes	Pipe diameter mm	Pipe wall thickness mm	Length of 20 mm thick insulation, LS or CS	Classification
Copper or Steel	15	1	1 m LS, 400 mm to both faces	EI 60 U/C
	15	1	CS, full length	EI 90 U/C
	22	1	1 m LS, 400 mm to both faces or CS	
	42	1.5	1 m LS, 400 mm to both faces	EI 90 U/C

5.3.3 **Non-flammable pipes** of steel & copper
with insulation **Armaflex Protect (LS) EI 90 "C/U"**

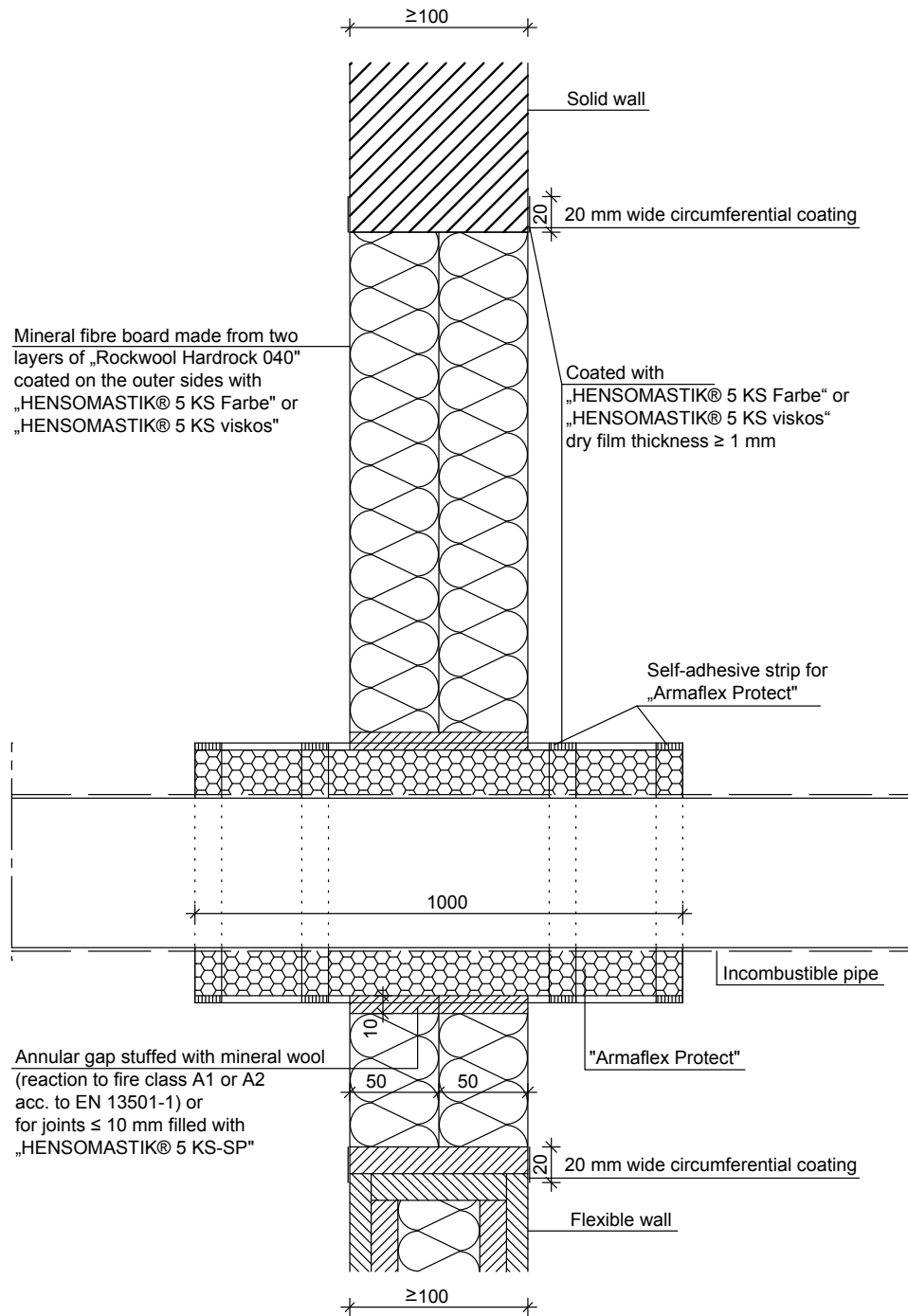

The length of the local insulation may be increased but not reduced.

Dimensions in mm

Services	Pipe diameter mm	Pipe wall thickness mm	Insulation thickness mm	Insulation length mm	Classification
Steel or cast iron pipe	Up to 22	1.0-14.2	19-20	1000	EI 90 C/U
	Up to 42	1.5-14.2	25	1000	
	Up to 76.1	2.0-14.2	25	1000	

5.3.4 **Non-flammable pipes** of steel & copper
with insulation Armaflex AF (LS) and HENSOTHERM® 7 KS Gewebe EI 90 "C/U"

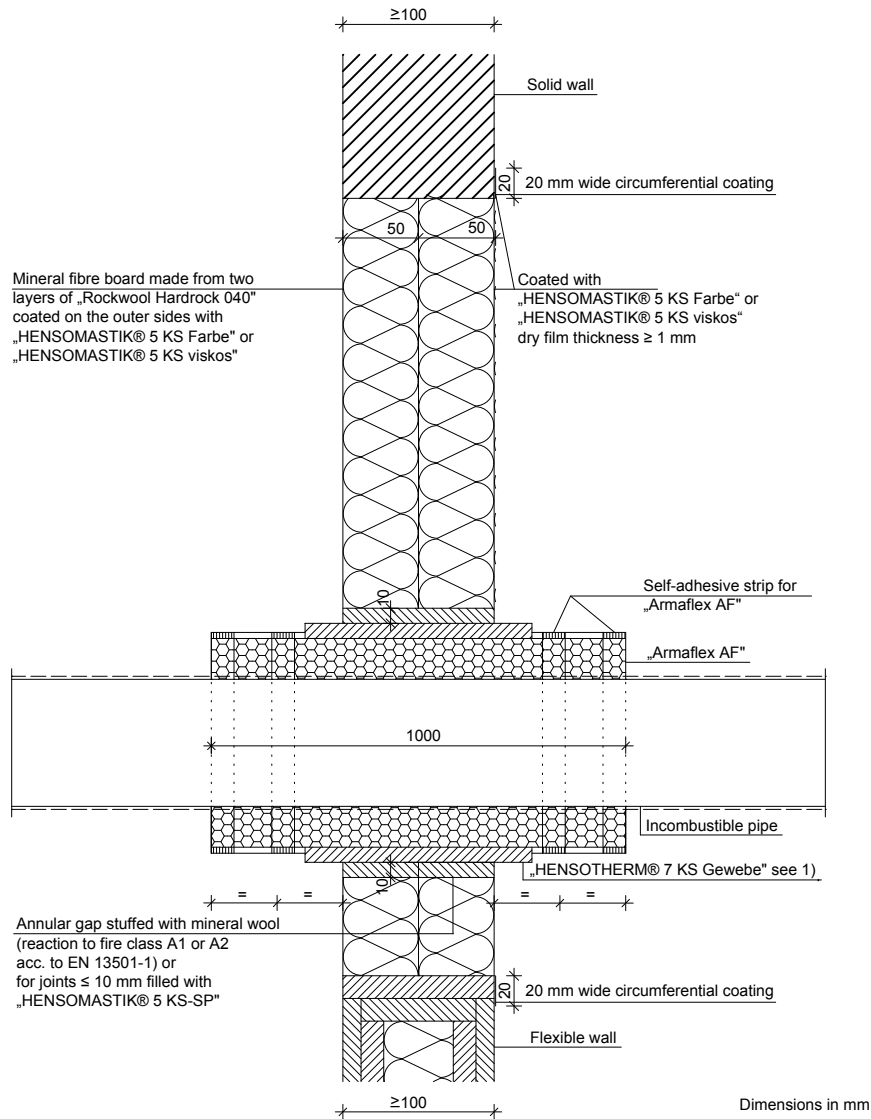

1) Pipe and insulation is required to be wrapped with two layers HENSOTHERM® 7 KS Gewebe bandage 125 mm long, to both sides of the penetration seal such that they are directly in contact at mid-depth of the seal and extend 75 mm from both faces of the penetration seal. The single layer of bandage shall be overlapped by 10 mm.

The length of the local insulation may be increased but not reduced.

5.3.4 **Non-flammable pipes** of steel & copper
with insulation Armaflex AF (LS) and HENSOTHERM® 7 KS Gewebe EI 90 “C/U”

Services	Pipe diameter mm	Pipe wall thickness mm	Insulation thickness mm	Classification
Steel, copper or cast iron pipe	Up to 10	1.0-5.0	12.5	EI 90 C/U
	Up to 22	1.0-11	18	
	Up to 54	1.5-14.2	28.5	
	Illustrated classified pipe dimensions			
<p>The graph shows the relationship between pipe diameter and wall thickness for copper and steel EI 90-C/U pipes. The x-axis represents Diameter (mm) from 0 to 60, and the y-axis represents Pipe wall thickness (mm) from 0 to 16. The data points are: (10, 1), (22, 1), (54, 1.5), and (10, 14.2).</p>				
Services	Pipe diameter mm	Pipe wall thickness mm	Insulation thickness mm	Classification
Steel or cast iron pipe	Up to 10	1.0-5.0	12.5	EI 90 C/U
	Up to 22	1.0-11	18	
	Up to 54	1.5-14.2	28.5	
	Up to 60.3	2.9-14.2	29	
	Up to 89.9	3.2-14.2	30.5	
Illustrated classified pipe dimensions				
<p>The graph shows the relationship between pipe diameter and wall thickness for steel EI 90-C/U pipes. The x-axis represents Diameter (mm) from 0 to 100, and the y-axis represents Pipe wall thickness (mm) from 0 to 16. The data points are: (10, 1), (22, 1), (54, 1.5), (88.9, 2), and (10, 14.2).</p>				

6. Assembly instructions for HENSOMASTIK® Mixed Penetration Seal EI 90 / EI 120 in rigid floor constructions with floor thickness of minimum 150 mm

Services	Types
Cables	<ul style="list-style-type: none"> • Sheathed electrical cables up to 80 mm diameter • Telecom cables up to 21 mm diameter
Cable bundles	<ul style="list-style-type: none"> • Bundles of the above up to 100 mm in diameter
Cable Supports	<ul style="list-style-type: none"> • Perforated and unperforated steel cable trays and ladders
Plastic pipes with AWM II pipe collars	<ul style="list-style-type: none"> • PE pipes in accordance with EN 1519-1, EN 12666-1, EN12201-2 • Friaphon (by FRIATEC) pipes • PVC-U pipes in accordance with EN 1329-1, EN 1453-1, EN 1452-1 • PP pipes in accordance with EN 1451-1
Plastic pipes with HENSOTHERM® 7KS Gewebe pipe wrap	<ul style="list-style-type: none"> • PE pipes in accordance with EN 1519-1, EN 12666-1, EN12201-2 • PVC-U pipes in accordance with EN 1329-1, EN 1453-1, EN 1452-1 • PP pipes in accordance with EN 1451-1
Metal pipes with Rockwool RS800 (LI) insulation	<ul style="list-style-type: none"> • Copper • Mild & stainless steel • Cast Iron
Metal pipes with Rockwool RS800 (LS) insulation	<ul style="list-style-type: none"> • Copper • Mild & stainless steel • Cast Iron
Metal pipes with Armaflex AF (LS) insulation	<ul style="list-style-type: none"> • Copper • Mild & stainless steel • Cast Iron
Metal pipes with Armaflex Protect (LS) insulation	<ul style="list-style-type: none"> • Copper • Mild & stainless steel • Cast Iron

Permitted Distances

Maximum seal size: 2000 mm x 1200 mm

- a1: between cable/cable trays and metal pipes ≥ 50 mm
- a2: between cable/cable trays and plastic pipes ≥ 50 mm
- a3: between metal pipes and plastic pipes ≥ 25 mm
- a4: between plastic pipes ≥ 40 mm
- a5: between metal pipes ≥ 40 mm
- a6: between cable trays ≥ 30 mm
- b1: between cable/cable trays and the upper seal edge: ≥ 25 mm
- b2: between cable/cable trays and the side seal edge: ≥ 25 mm
- b3: between cable/cable trays and the lower seal edge: ≥ 0 mm
- b4: between metal pipes and the side seal edge: ≥ 30 mm
- b5: between plastic pipes and the side seal edge: ≥ 30 mm

Distance 1st support pipe service ≤ 450 mm

Distance 1st support cable/cable trays ≤ 240 mm

6.1 Application and fitting with electric cables and trays EI 90

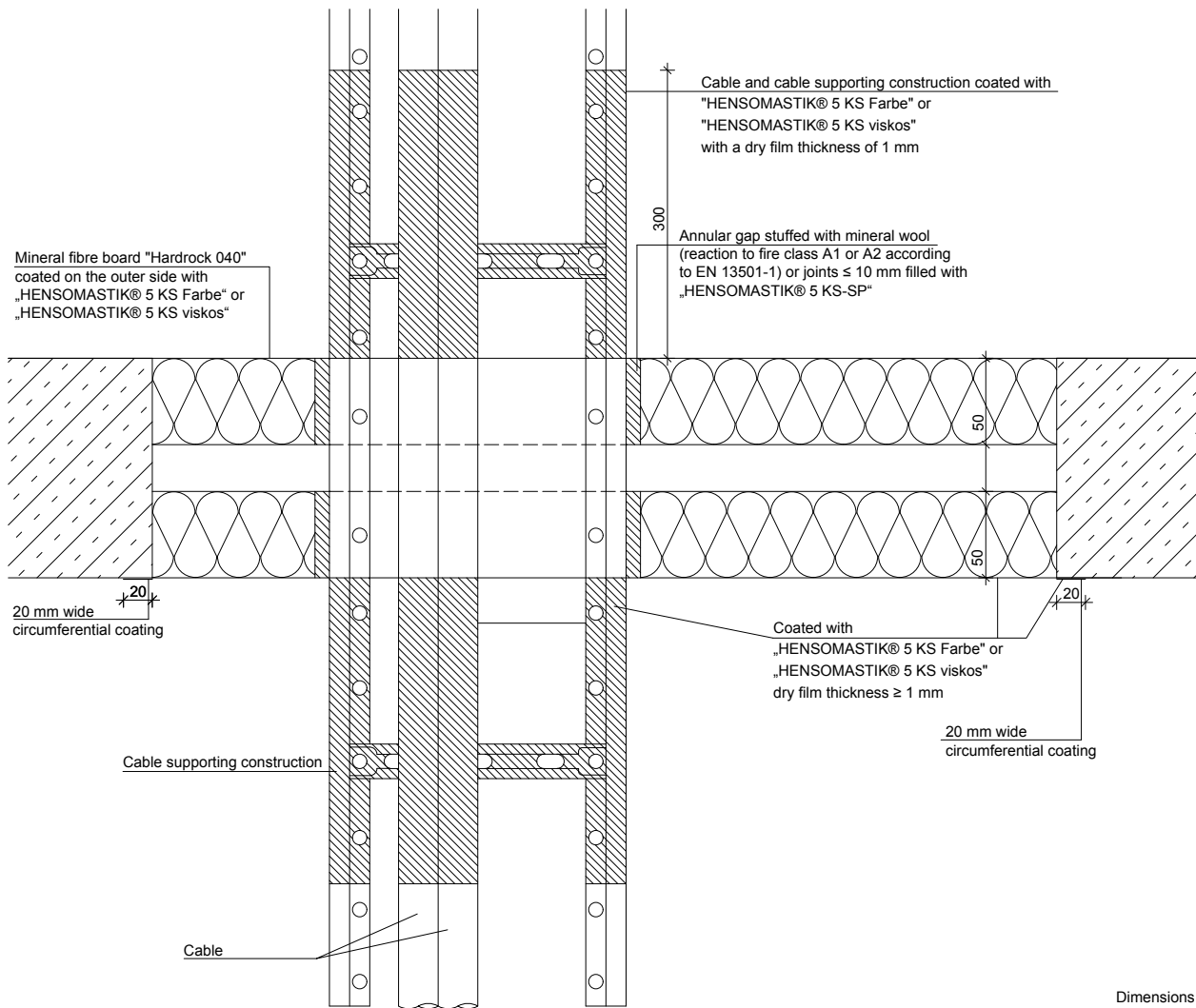

Services	Insulation/Coating	Classification
Sheathed electrical cables up to 21 mm diameter	1 mm DFT HENSOMASTIK 5KS Farbe coating extending 300 mm from both faces of the seal	EI 90
Telecoms cables up to 21 mm diameter		
Bundles of above cables up to 100 mm diameter		
Cable supports		

6.2 Plastic pipes and conduits with **AWM II EI90 / EI120 "U/U"**

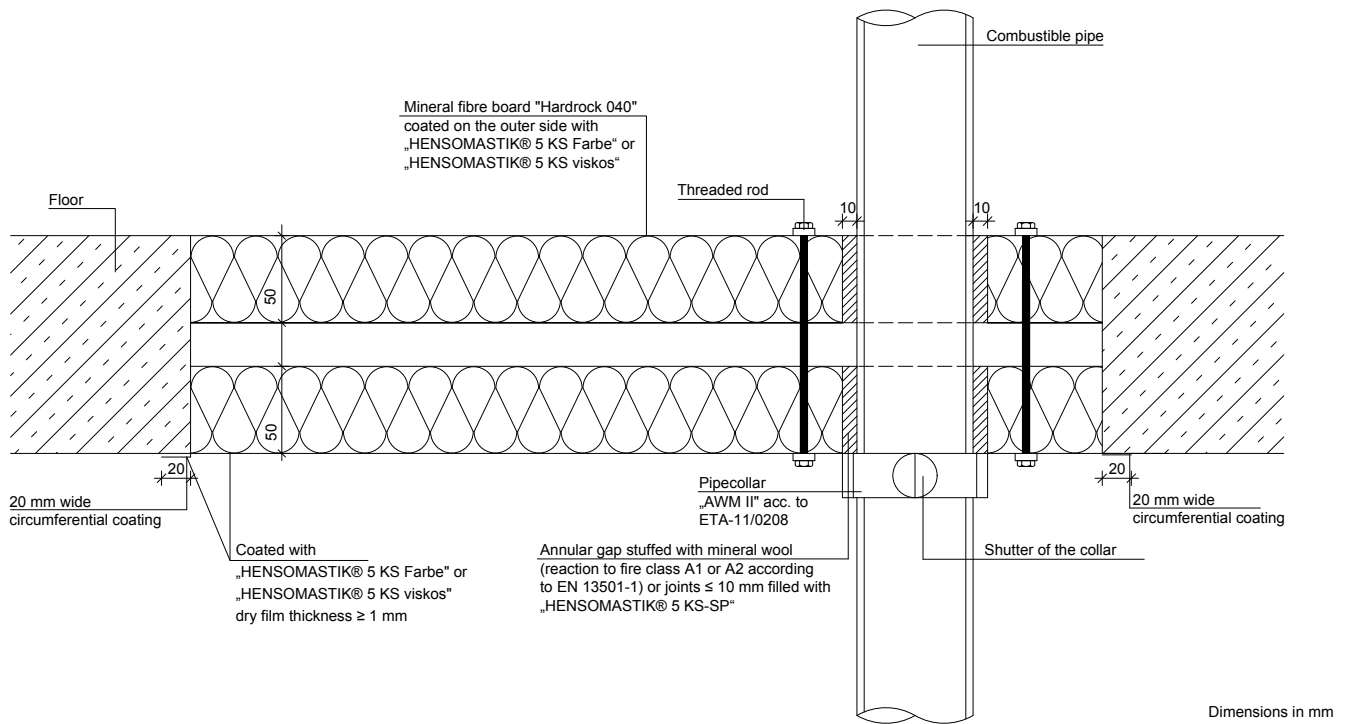

Services	Pipe diameter mm	Pipe wall thickness mm	Collar inlay size mm	Classification
Friaphon pipe	52	2.8	75 x 6	EI 90 U/U
	78	4.9		
	110	5.3		
	135	5.6	75 x 12	

6.2 Plastic pipes and conduits with **AWM II EI 90 / EI 120 "U/U"**

Services	Pipe diameter mm	Pipe wall thickness mm	Collar inlay size mm	Classification
PVC-U pipe	32	1.8-5.6	25.4 x 6.4	EI 120 U/U
	40			
	50			
	63	1.8-12.3	25.4 x 12.8	
	75			
	90			
	110	2.5-9.2	25.4 x 19.2	
	125			
	140	3.2	38.1x25.6	EI 90 U/U
	160			
	140	11.8	38.1x25.6	EI 60 U/U
	160			

Illustrated classified pipe dimensions

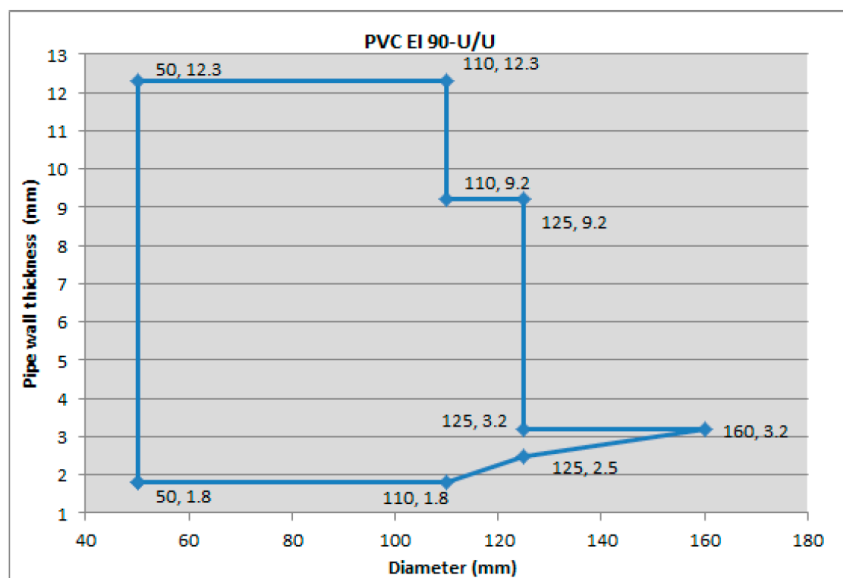
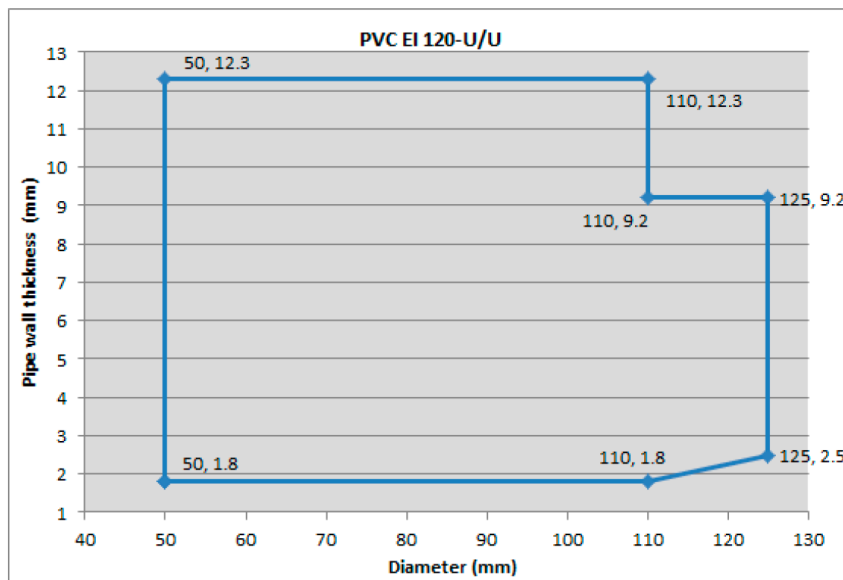

6.2 Plastic pipes and conduits with **AWM II EI90 / EI120 "U/U"**

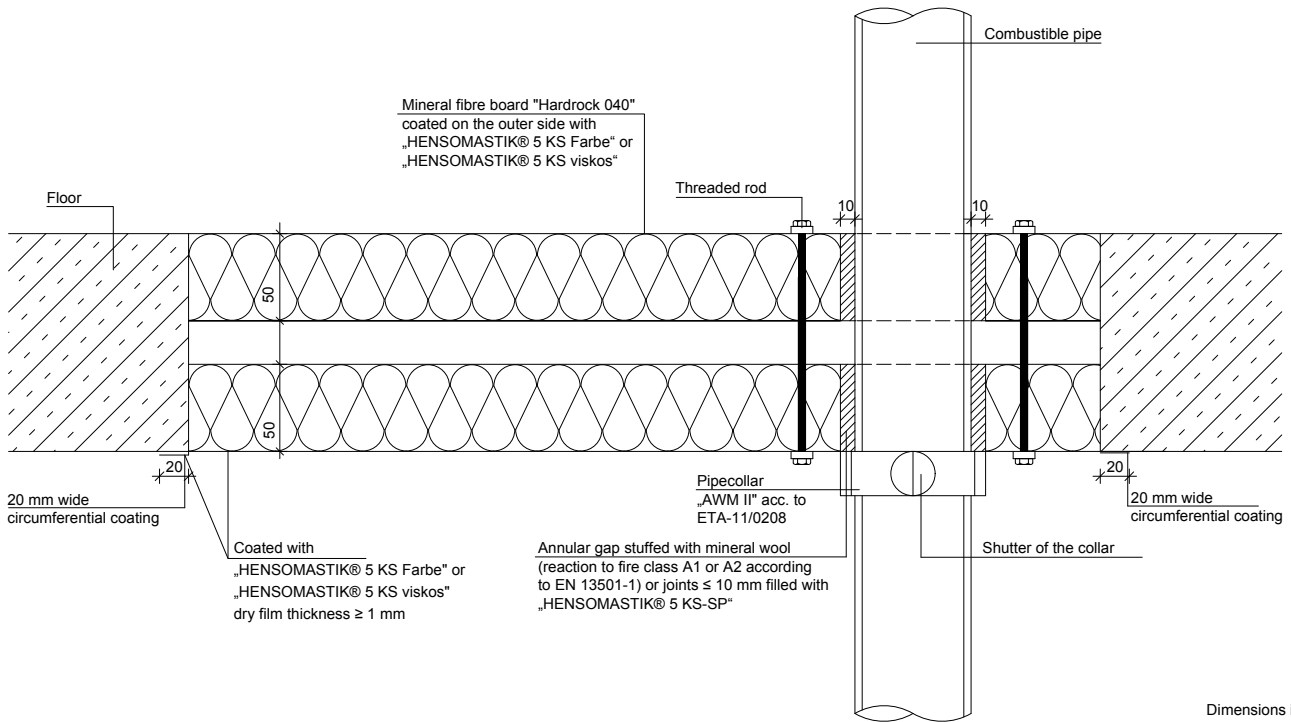

Services	Pipe diameter mm	Pipe wall thickness mm	Collar inlay size mm	Classification	
PE pipe	32	1.8-4.6	25.4 x 6.4	EI 120 U/U	
	40				
	50				
	63	2.7-10.0	25.4 x 12.8		
	75				
	90				
	110				
	125	3.1-11.4	25.4 x 17.1		
	140	4.0-14.6			25.4 x 19.2
	160				

Illustrated classified pipe dimensions

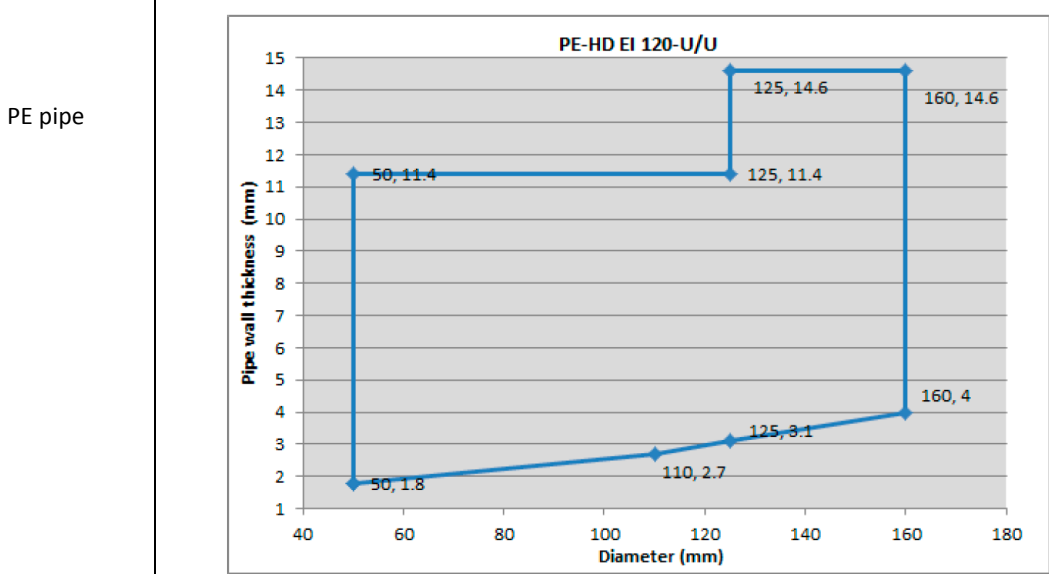

6.2 Plastic pipes and conduits with **AWM II EI 90 / EI 120 “U/U”**

Services	Pipe diameter mm	Pipe wall thickness mm	Collar inlay size mm	Classification
PP pipe	32	1.8-4.6	25.4 x 6.4	EI 120 U/U
	40			
	50			
	63	2.7-10.0	25.4 x 12.8	
	75			
	90			
	110			
Illustrated classified pipe dimensions				
<p>The graph shows the relationship between pipe diameter and wall thickness for PP EI 120-U/U pipes. The x-axis represents Diameter (mm) from 40 to 130, and the y-axis represents Pipe wall thickness (mm) from 1 to 12. Four data points are plotted: (50, 1.8), (50, 10), (110, 2.7), and (110, 10). A blue line connects these points, indicating that for a 50 mm diameter, the wall thickness can be 1.8 mm or 10 mm, and for a 110 mm diameter, it can be 2.7 mm or 10 mm.</p>				

Services	Pipe diameter mm	Cables*	Collar inlay size mm	Classification
Polyolefin conduits bundled to fill a 125 mm Ø collar	16	None	38.1 x 25.6	EI 120 U/C
	20			
	25			
	32			
	40			
	50			
	63			
	16	1x JY(ST) 2x2x0.6		
	20	1x A2		
	25	1x A1		
	32	1x F		
	40	2x A1		
	50	2x A1, 2x F		
	63	4x A1, 3x F		

* Cables as designated in EN 1366-3: 2009

6.3 Plastic and composite pipes with HENSOTHERM® 7 KS Gewebe pipe wraps

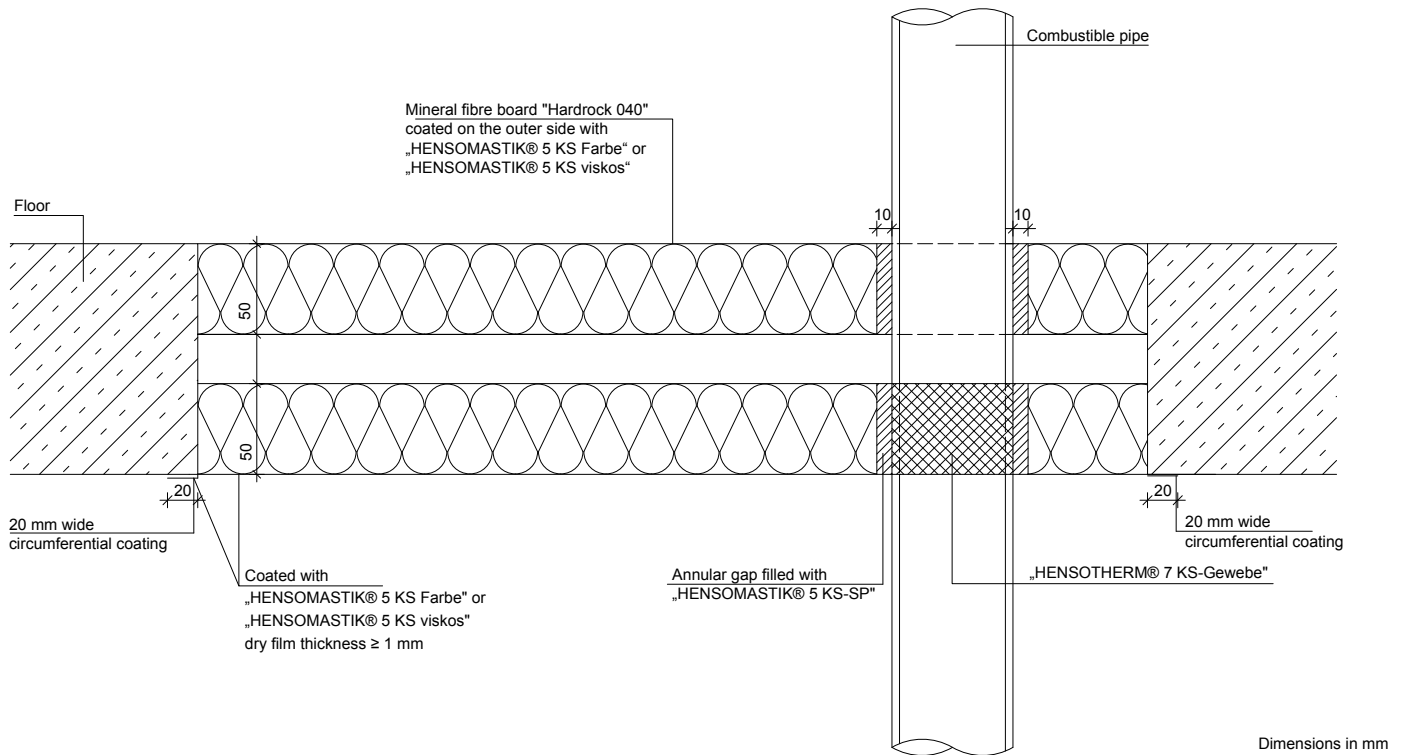

Pipes	Maximum Pipe diameter mm	Pipe wall thickness mm	Layers of HENSOTHERM 7KS Gewebe pipe wrap	Classification
PE-HD	56	3	2	EI 90 U/U
	90	3.5	4	EI 120 U/U
PP-HT	50	1.8	2	EI 60 U/U E 90 U/U
	75	1.9	3	EI 90 U/U
	90	2.2	4	
Geberit Silent dB20	56	3.2	2	EI 120 U/U
	90	5.5	4	
Geberit Silent PP	50	1.8	2	EI 90 U/U E 120 U/U
	90	2.9	4	EI 90 U/U
Geberit Melpa	32	3.0	3	EI 120 U/U
	63	4.5	4	
Polokal NG	50	2	2	EI 60 U/U E 120 U/U
	90	3	4	EI 120 U/U
Polokal 3S	75	3.8	3	
	90	4.5	4	
Flex-Schlauch	25*	2	2	
	32^	2	4	

* With or without 1x NYM-J, 5RE cable

^ With or without 1x NYM-J 5x6, 0 RE cable

6.3 Plastic and composite pipes with HENSOTHERM® 7 KS Gewebe pipe wraps

Pipes	Maximum Pipe diameter mm	Pipe wall thickness mm	Layers of HENSOTHERM 7KS Gewebe pipe wrap	Classification
PVC-U	50	2.4	2	EI 90 U/U E 120 U/U
	50	3.7	2	EI 120 U/U
	75	3.6	3	
	75	5.6	3	EI 90 U/U
	90	4.3	4	EI 90 U/U E 120 U/U
	90	6.7	4	EI 90 U/U
Illustrated classified pipe dimensions				

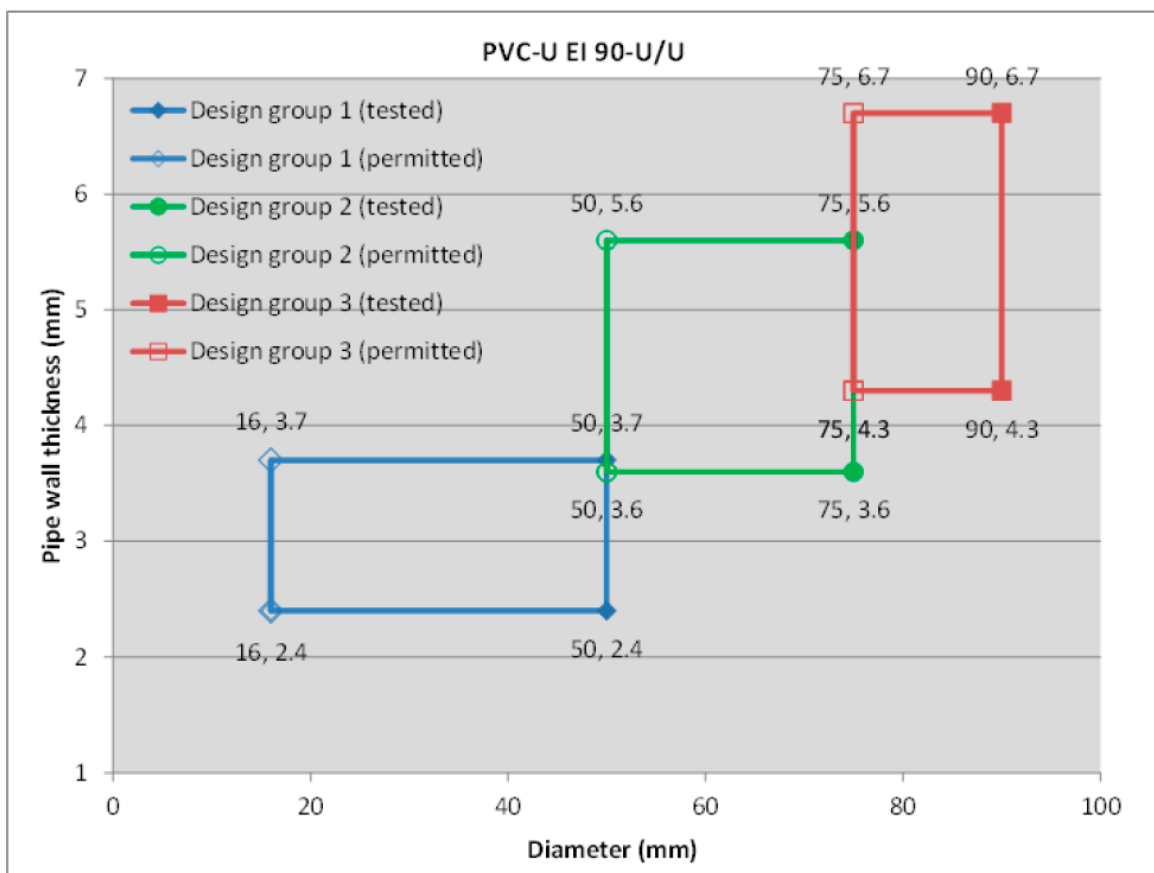

Permitted pipe Ø/wall thickness mm	Number of layers	Length of wrap mm	Design group
16x2.4-50x3.6	2	50	1
50x3.6-75x5.6	3	50	2
75x4.3-90x6.7	4	50	3

6.4 Application and fitting with **non-flammable pipes EI 90 / EI 120**

6.4.1 **Non-flammable pipes** of steel & copper

with sectional insulation Rockwool RS 800 (LI), length 2 × 1,000 mm, EI 120 "U/C"

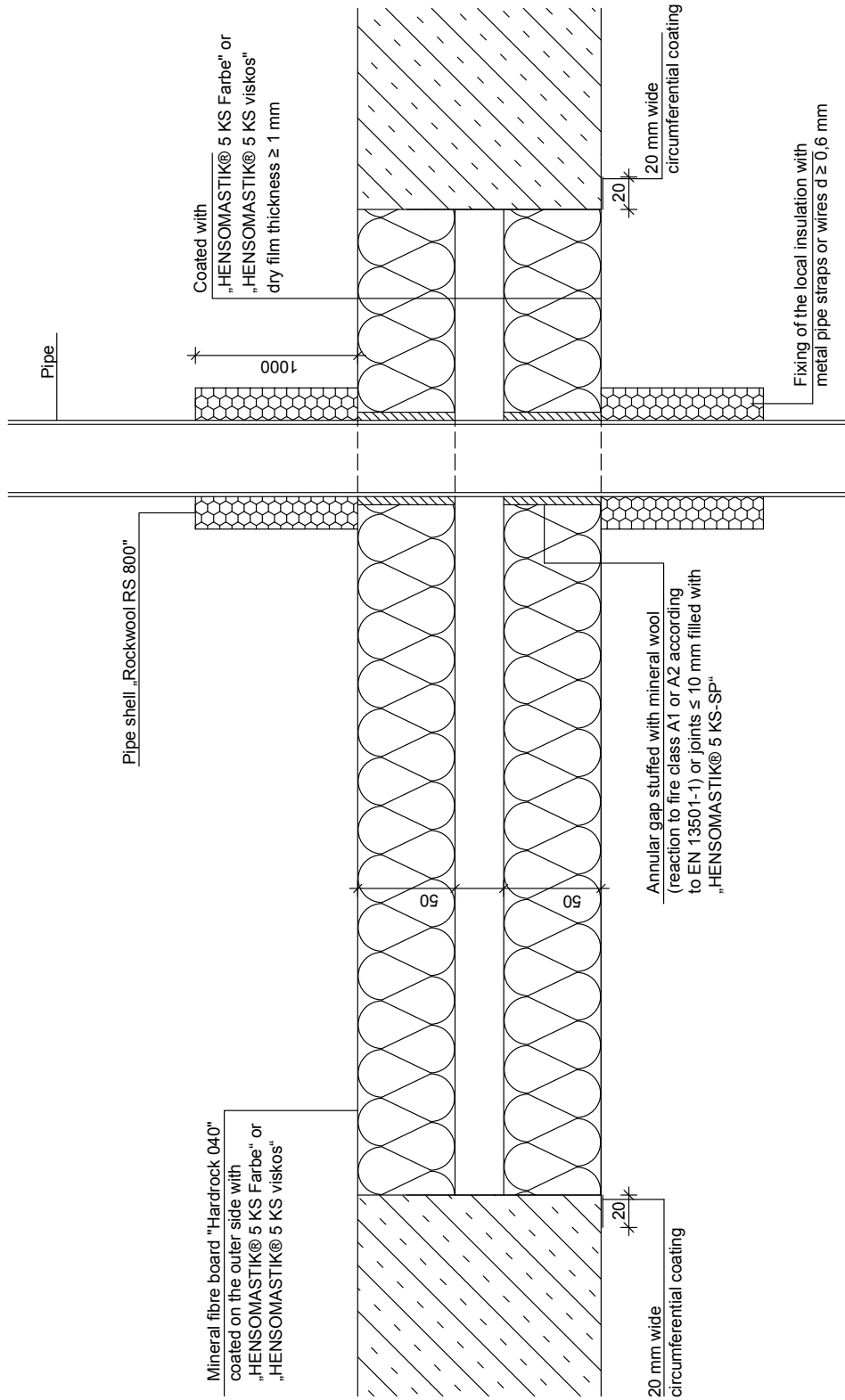

Dimensions in mm

The length of the local insulation may be increased but not reduced.
The density of the insulation may be increased but not reduced.

6.4.1 **Non-flammable pipes** of steel & copper
with sectional insulation Rockwool RS 800 (LI), length 2 × 1,000 mm, EI 120 “U/C”

Services	Pipe diameter mm	Pipe wall thickness mm	Insulation thickness mm	Classification
Steel or cast iron pipe	Up to 20	1.0-11	20 (min.)	EI 120 U/C
	Up to 48.3	2.6-14.2		
	Up to 139.7	4.0-14.2	30 (min.)	
	Illustrated classified pipe dimensions			

Services	Pipe diameter mm	Pipe wall thickness mm	Insulation thickness mm	Classification
Copper pipe	Up to 20	1.0-11	20 (min.)	EI 120 U/C
	Up to 42	1.5-14.2		
	Up to 88.9	2.0-14.2	30 (min.)	
	Illustrated classified pipe dimensions			

6.4.2 Non-flammable pipes of steel & copper

with insulation Armaflex AF (LS), length 2,000 mm and HENSOTHERM® 7 KS Gewebe EI 90 / EI 120 “C/U”

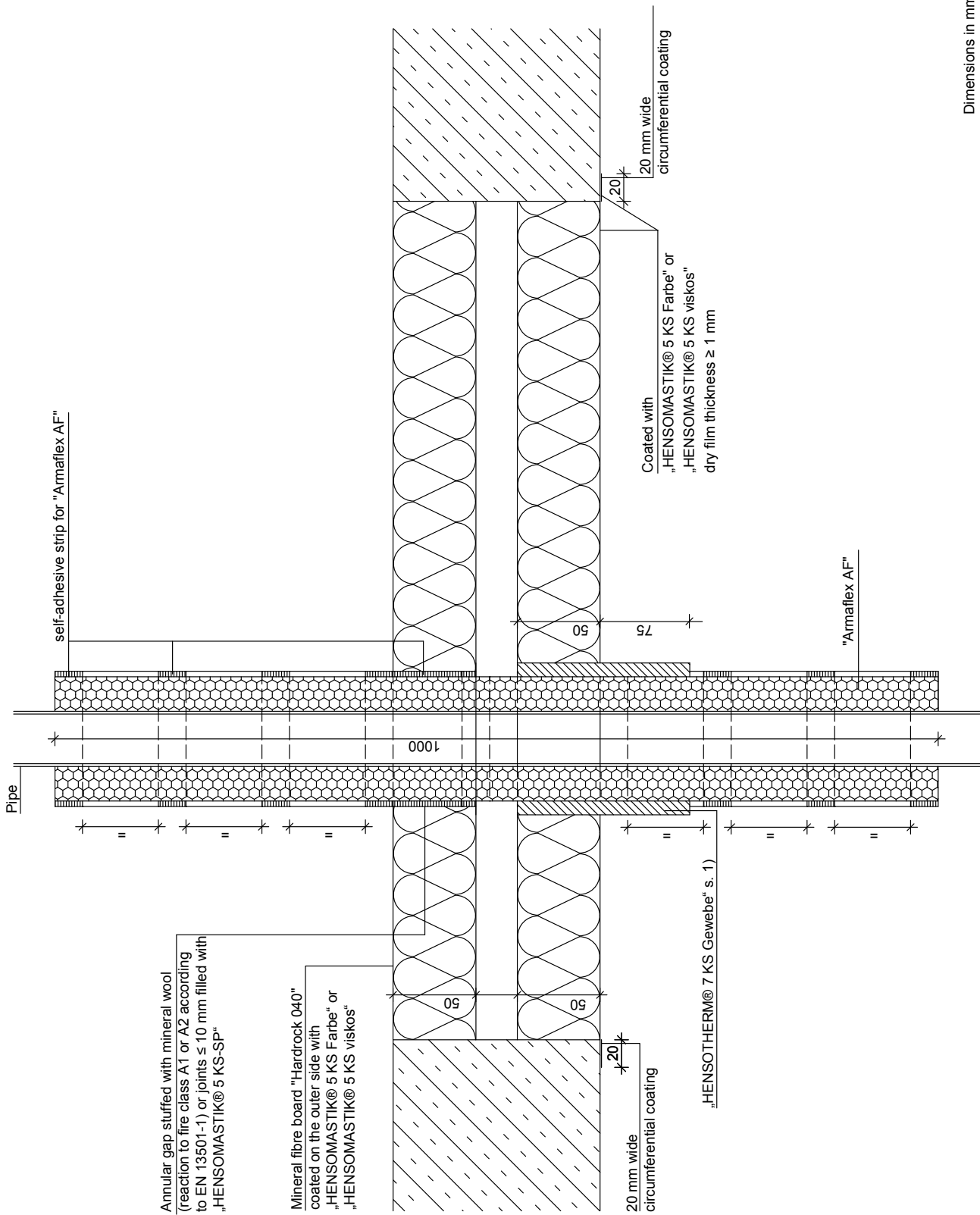

Dimensions in mm

1) Pipe and insulation is required to be wrapped with two layers of "HENSOTHERM® 7 KS Gewebe" bandage 125 mm long, in the middle of the bottom Rockwool slab, extending 75 mm from the penetration seal. The single layer of bandage shall be overlapped by 10 mm. The bandage has to be fixed with wires $d \geq 0.6$ mm.

6.4.2 Non-flammable pipes of steel & copper

with insulation Armaflex AF (LS), length 2,000 mm and HENSOTHERM® 7 KS Gewebe EI 90 / EI 120 “C/U”

Services	Pipe diameter mm	Pipe wall thickness mm	Insulation thickness mm	Classification
Steel or cast iron pipe	Up to 10	1.0-5.0	11	EI 120 C/U
	Up to 22	1.0-11	18	
	Up to 54	1.5-14.2	28.5	EI 90 C/U
	Up to 60.3	2.9-14.2	29	EI 120 C/U
	Up to 88.9	3.2-14.2	30.5	EI 90 C/U

Illustrated classified pipe dimensions

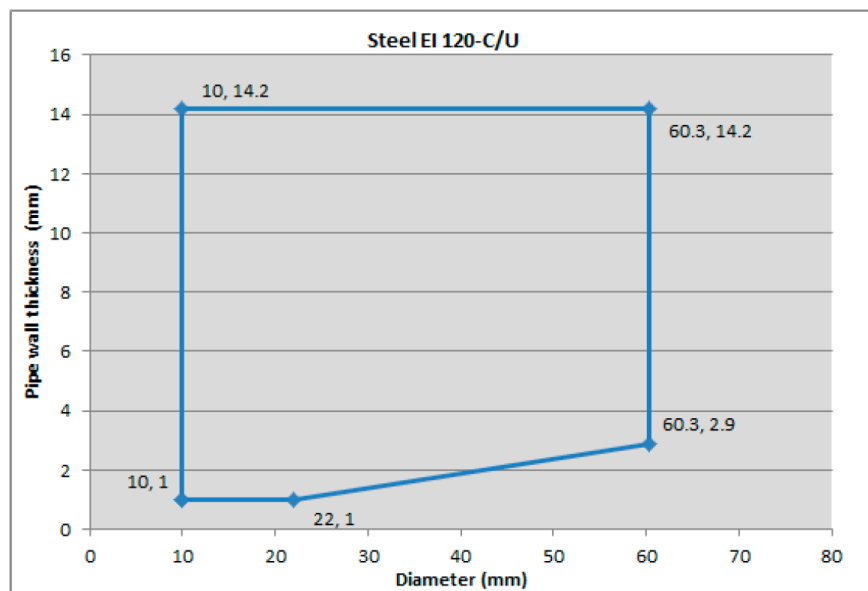
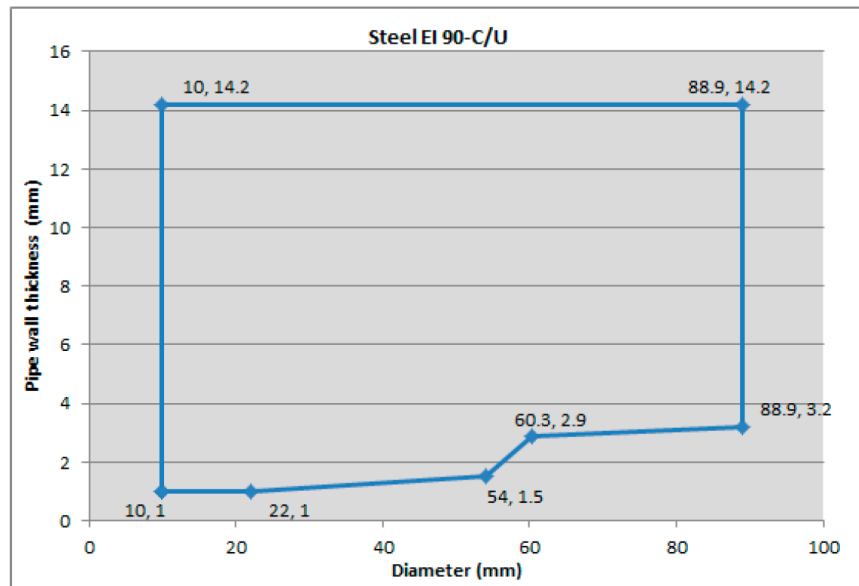

6.4.2 Non-flammable pipes of steel & copper

with insulation Armaflex AF (LS), length 2,000 mm and HENSOTHERM® 7 KS Gewebe EI 90 / EI 120 "C/U"

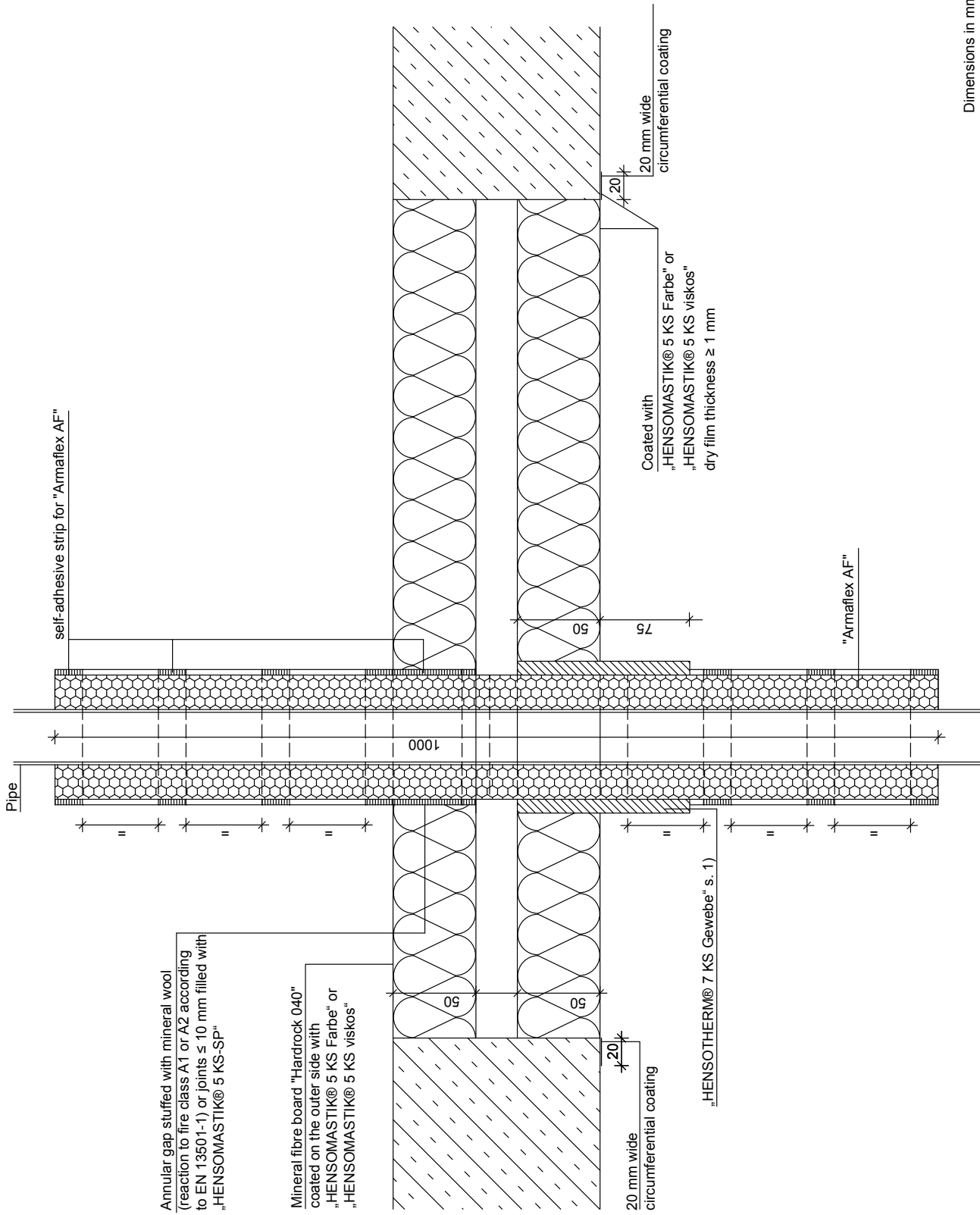

Dimensions in mm

- 1) Pipe and insulation is required to be wrapped with two layers of "HENSOTHERM® 7 KS Gewebe" bandage 125 mm long, in the middle of the bottom Rockwool slab, extending 75 mm from the penetration seal. The single layer of bandage shall be overlapped by 10 mm. The bandage has to be fixed with wires $d \geq 0,6$ mm.

6.4.2 Non-flammable pipes of steel & copper

with insulation Armaflex AF (LS), length 2,000 mm and HENSOTHERM® 7 KS Gewebe EI 90 / EI 120 “C/U”

Services	Pipe diameter mm	Pipe wall thickness mm	Insulation thickness mm	Classification										
Copper pipe	Up to 10	1.0-5.0	12.5	EI 120 C/U										
	Up to 22	1.0-11	18											
	Up to 54	1.5-14.2	28.5	EI 90 C/U										
Illustrated classified pipe dimensions														
<p>Copper EI 90-C/U</p> <table border="1"> <caption>Data for Copper EI 90-C/U Graph</caption> <thead> <tr> <th>Diameter (mm)</th> <th>Pipe wall thickness (mm)</th> </tr> </thead> <tbody> <tr> <td>10</td> <td>14.2</td> </tr> <tr> <td>54</td> <td>14.2</td> </tr> <tr> <td>54</td> <td>1.5</td> </tr> <tr> <td>10</td> <td>1</td> </tr> </tbody> </table>					Diameter (mm)	Pipe wall thickness (mm)	10	14.2	54	14.2	54	1.5	10	1
Diameter (mm)	Pipe wall thickness (mm)													
10	14.2													
54	14.2													
54	1.5													
10	1													
<p>Copper EI 120-C/U</p> <table border="1"> <caption>Data for Copper EI 120-C/U Graph</caption> <thead> <tr> <th>Diameter (mm)</th> <th>Pipe wall thickness (mm)</th> </tr> </thead> <tbody> <tr> <td>10</td> <td>14.2</td> </tr> <tr> <td>22</td> <td>14.2</td> </tr> <tr> <td>22</td> <td>1</td> </tr> <tr> <td>10</td> <td>1</td> </tr> </tbody> </table>					Diameter (mm)	Pipe wall thickness (mm)	10	14.2	22	14.2	22	1	10	1
Diameter (mm)	Pipe wall thickness (mm)													
10	14.2													
22	14.2													
22	1													
10	1													

6.4.3 **Non-flammable pipes** of steel & copper
with insulation Armaflex Protect (LS), length 2,000 mm, EI 120 "C/U"

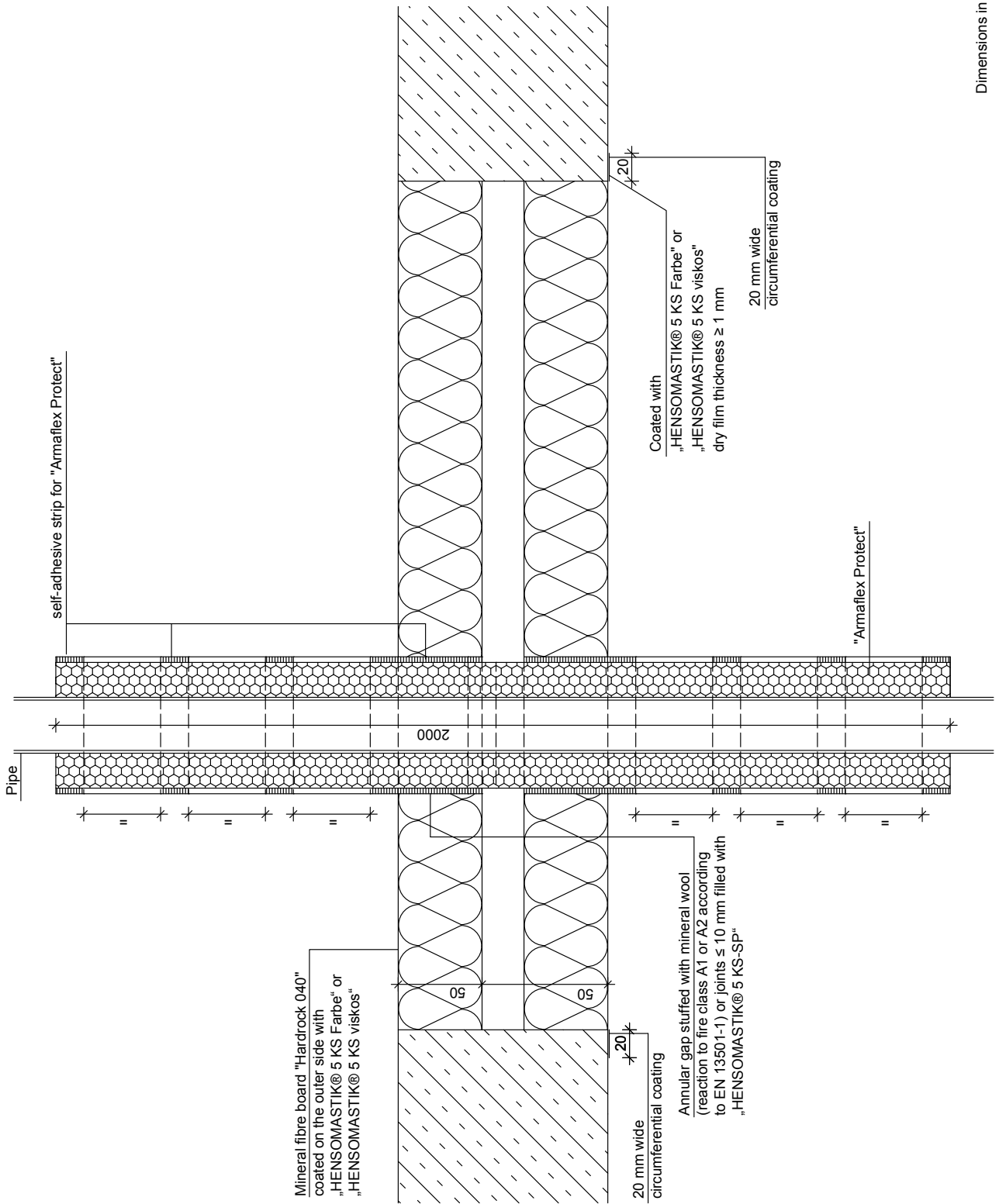

Dimensions in mm

6.4.3 **Non-flammable pipes** of steel & copper
with insulation Armaflex Protect (LS), length 2,000 mm, EI 120 “C/U”

Services	Pipe diameter mm	Pipe wall thickness mm	Insulation thickness mm	Classification										
Copper, Steel or cast iron pipe	Up to 15	1.0-11	19	EI 120 U/C										
	Up to 22	1.0-11	20											
	Up to 42	1.5-14.2	25											
	Up to 76.1	2.0-14.2	25											
Illustrated classified pipe dimensions														
<p>Copper EI 120-U/C</p> <table border="1"> <caption>Data points from the graph</caption> <thead> <tr> <th>Diameter (mm)</th> <th>Pipe wall thickness (mm)</th> </tr> </thead> <tbody> <tr> <td>15</td> <td>1</td> </tr> <tr> <td>22</td> <td>1</td> </tr> <tr> <td>42</td> <td>1.5</td> </tr> <tr> <td>76.1</td> <td>2</td> </tr> </tbody> </table>					Diameter (mm)	Pipe wall thickness (mm)	15	1	22	1	42	1.5	76.1	2
Diameter (mm)	Pipe wall thickness (mm)													
15	1													
22	1													
42	1.5													
76.1	2													

FIRE PROTECTION OUR PASSION

RUDOLF HENSEL GMBH

Lack- und Farbenfabrik

Lauenburger Landstraße 11
21039 Börnsen | Germany

Tel. +49 (0)40 /72 10 62-10
Fax +49 (0)40 /72 10 62-52

E-Mail: info@rudolf-hensel.de
Internet: www.rudolf-hensel.de

Technical Support / Sales
Tel. +49 (0)40 /72 10 62-48

